

# Mediant™ 4000B Session Border Controller

## Quick Setup Guide

---

### Welcome

Congratulations on purchasing your AudioCodes **Mediant 4000B Session Border Controller (SBC)**, hereafter referred to as *device*!

This document is intended to provide only basic setup instructions for initial access to the device and for connecting it to your network.

Before you begin, please read the Safety Precautions on page 9.

 Pour consulter le guide rapide de l'équipement en **français**, consultez le site web AudioCodes suivant : <https://www.audiocodes.com/library/technical-documents?productGroup=1645&docTypeGroup=Quick+Guides>.

---

### Package Contents

Make sure that the following items (in addition to any separate-orderable item that you may have purchased) are included with your shipped device:

- 4 x anti-slide rubber feet for desktop mounting
- Adjustable rear-mounting brackets for 19-inch rack mounting
- 2 x front-mounting brackets with six screws for 19-inch rack mounting
- 1 x serial interface cable adaptor
- 2 x AC power cables (if ordered for AC power)
- 2 x DC power feed cables terminated with a crimp-connection type DC terminal block (if ordered for DC power)



# Physical Description of Front Panel



















[Number and type of modules depend on ordered hardware configuration]

- 1 Fan Tray module #1 and a **STATUS** LED indicating status of fan and Power Supply #2 module:
  - Green On Fan Tray module and Power Supply module are operating normally.
  - Red On Any of the following:
    - Fan Tray module failure.
    - Power failure due to any of the following:
      - Power Supply module failure.
      - Failure in power source (e.g., disconnected power cable).
      - Power Supply module is not installed.
  - Off Any of the following:
    - Fan Tray module is not receiving power due to a failure in the module or the module is not installed correctly.
    - No power received by the chassis due to a problem with both Power Supply modules (failure in both Power Supply modules or a failure in the power source, for example, power cables are disconnected).
  
- 2 (Slots 1 and 2) Figure shows unused chassis slots covered by slot covers. The two slots can house an optional Media Processing Module (MPM) that provides additional digital signaling resources (DSP) for transcoding sessions. The MPM module occupies two slots.  
**Note:** The MPM is a separate orderable item.
  
- 3 (Slots 3 and 4) SBC CPU AMC module, occupying two chassis slots. The module provides the following:
  - Central processing unit (CPU).
  - RS-232 port interface (**IOIO**) for serial communication.
  - Reset pinhole button (//) for resetting the device (press up to 5 seconds) and for restoring the device to factory defaults (press 15 to 20 seconds, not more).
  - 8 x 1000Base-T Gigabit Ethernet ports for connecting to the IP network. The ports operate in active-standby pairs, providing 1+1 Ethernet port redundancy. The ports support half- and full-duplex modes, auto-negotiation, straight-through and crossover cable detection.

The module provides the following LEDs:

- |                                     |  |   |
|-------------------------------------|--|---|
| <input checked="" type="checkbox"/> | <ul style="list-style-type: none"> <li><span style="color: green;">■</span> Green On</li> <li><span style="color: black;">■</span> Off</li> </ul>  | <ul style="list-style-type: none"> <li>Module in service.</li> <li>Module out of service.</li> </ul>                                      |
| <input type="checkbox"/>            | <ul style="list-style-type: none"> <li><span style="color: green;">■</span> Green On</li> <li><span style="color: red;">■</span> Red On</li> <li><span style="color: black;">■</span> Off</li> </ul> | <ul style="list-style-type: none"> <li>Normal operation.</li> <li>Booting up or fault detected in module.</li> <li>Booting up.</li> </ul> |

	 Green On	Application running in Standalone state.
	 Green Flashing	Application running in High-Availability (HA) Active state.
	 Yellow On	Application is starting bootup, or HA synchronization.
	 Yellow Flashing	Application is running in HA Redundant state.
	 Off	Booting up.
	 Red On	Out of service.
	 Off	Normal operation.
	 Blue On	Blue hot-swap LED indicating that the module can now be fully extracted or inserted. <b>Note:</b> Remove the module only if the LED is blue.
	 Off	Module insertion process is complete.
Left Ethernet Port	 Green On	Ethernet link established.
	 Green Flashing	Data is being received or transmitted on the Ethernet port.
	 Off	No Ethernet link.
Right Ethernet Port	 Orange On	1000Base-T Gigabit Ethernet link established.
	 Off	No Ethernet link or 100Base-Tx link established.

- 4 (Slots 5 and 6) Figure shows unused chassis slots covered by slot covers. The slots can house one of the following optional modules:
  - MPM module (only if an MPM module is also housed in slots 1 and 2). The MPM module occupies two slots.
  - OSN server modules, where the OSN4 module is housed in Slot 5 and the HDMX module in Slot 6. The OSN platform can be used to host third-party applications (e.g., IP PBX).**Note:** The MPM and OSN modules are separate orderable items.
  
- 5 (Slots 7 and 8) Figure shows unused chassis slots covered by slot covers. The slots can house one of the following optional modules:
  - MPM module (only if MPM modules are also housed in slots 1 and 2, and 5 and 6). The MPM module occupies two slots.
  - Secondary HDMX module for the OSN server. The module is installed in Slot 7.**Note:** The MPM and HDMX modules are separate orderable items.
  
- 6 Fan Tray module #2 with a schematic of the chassis' slot numbers and a **STATUS** LED indicating status of fan and Power Supply module #1. For LED descriptions, see Item #1 (above).

## Mounting the Device

You can mount the device on a desktop using the four anti-slide rubber feet (supplied), which you need to stick on the grooves located on the underside of the device.

You can also mount the device in a standard 19-inch rack, by placing it on a pre-installed rack shelf (not supplied), and then securing it to the rack frame using front-mounting brackets (supplied). For additional 19-inch rack mounting options, refer to the *Mediant 4000B SBC Hardware Installation Manual*.

# Powering the Device

The device provides two hot swappable Power Supply modules, providing load sharing and 1+1 power redundancy in case of failure in one of the Power Supply modules. Depending on ordered power type, the device is powered from a standard alternating current (AC) electrical wall outlet or from a direct current (DC) power source.

## Protective Earthing (Grounding)

The device must always be earthed (grounded). Connect an electrically earthed strap of 16-AWG wire (minimum) to the chassis' grounding lug screw (located on the rear panel), and then connect the other end of the strap to protective earthing.

### Connecting to an AC power source:

1. Insert the female socket, on one end of the power cord (supplied), into the AC inlet of one of the Power Supply modules, located on the rear panel.
2. Insert the plug, on the other end of the power cord, into the AC electrical wall outlet.
3. Repeat the above steps for the second Power Supply module, but connect it to a different AC power source.

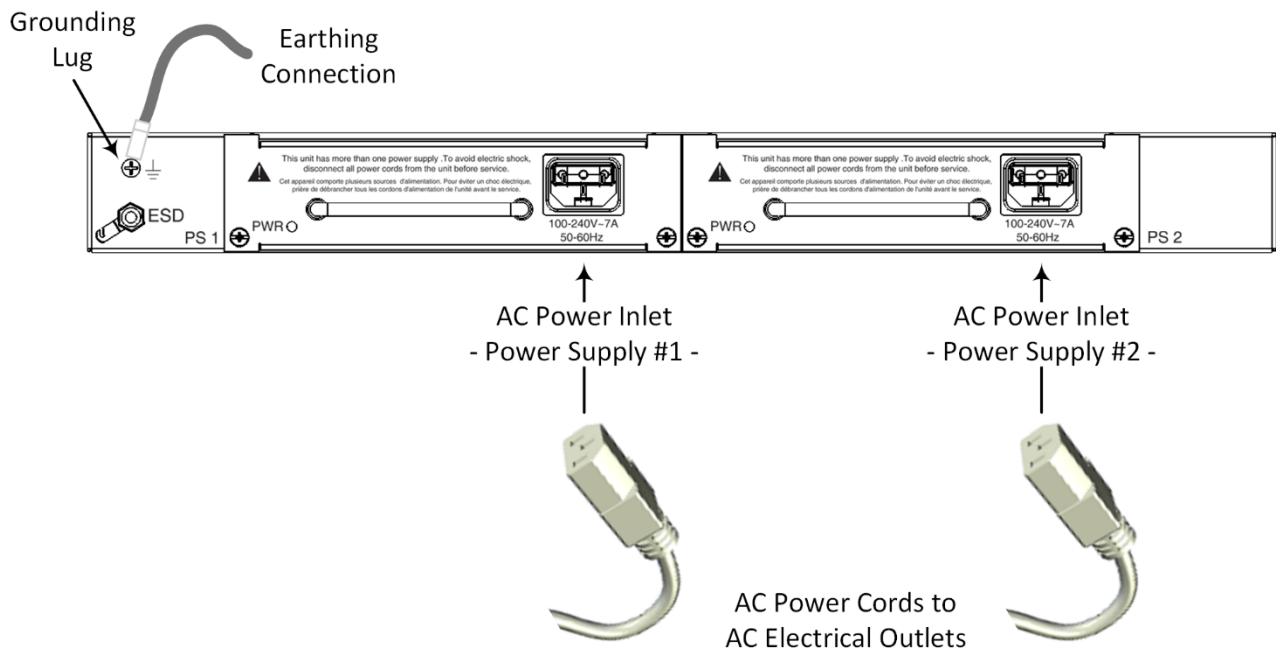

### Connecting to DC power source:

1. Connect the open ends of the two wires on the DC power feed cable (supplied) to the DC power source. Make sure that the wires are connected to the correct polarity (**black** wire negative; **red** wire positive).
2. Plug the DC power feed cable, crimped to the terminal block, into the DC inlet of one of the Power Supply modules, located on the rear panel. Make sure that the hook on the terminal block snaps into the groove above the inlet.
3. Repeat the above steps for the second Power Supply module, but connect it to a different DC power source.

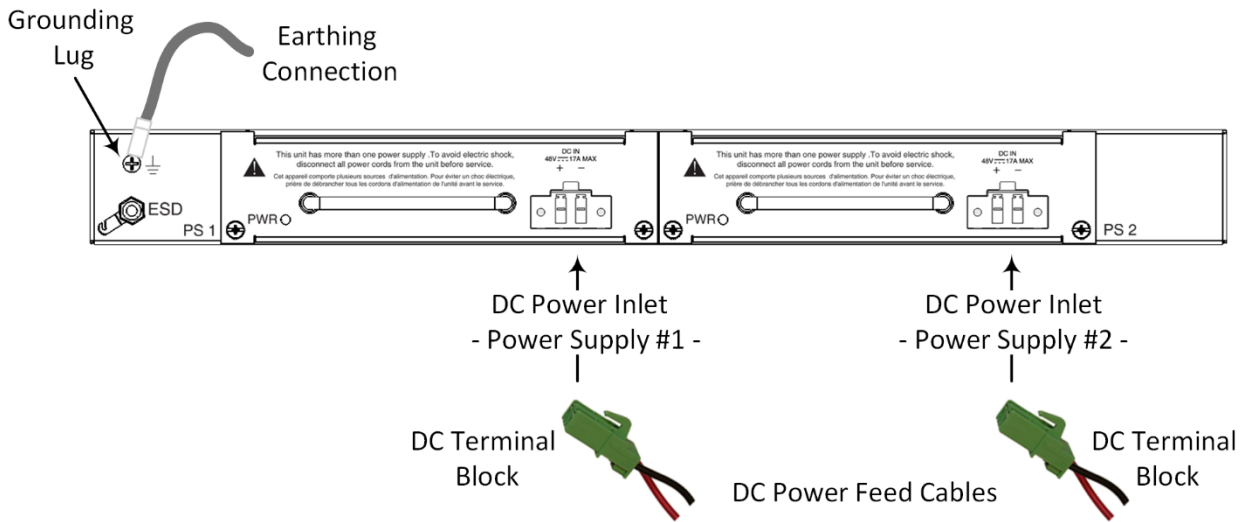

# Assigning an IP Address

Use the device's factory default IP address (192.168.0.2/24 and Default Gateway 0.0.0.0) to initially access the device's Web-based management interface and then change it to suit your network's addressing scheme for subsequent connectivity.

1. Using a CAT-5e or CAT-6 straight-through RJ-45 Ethernet cable, connect Ethernet port GE 1 or GE 2, located on the SBC module on the device's front panel, to your computer's LAN port.

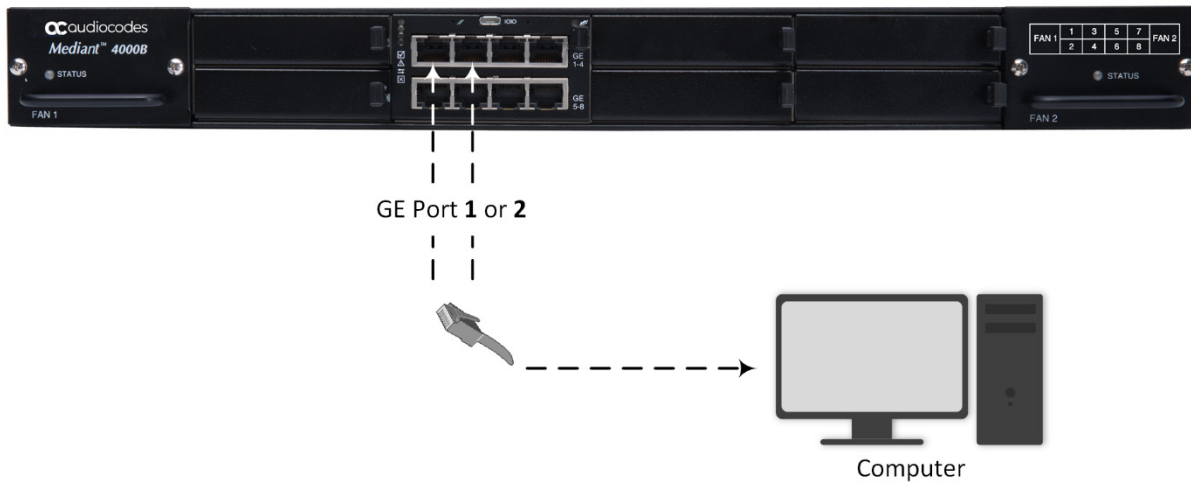

2. Change the IP settings of your computer to correspond with the device's default IP address and subnet mask.
3. On your computer, open a standard Web browser (for example, Google Chrome), and then in the URL field, enter the device's default IP address; the Web Login screen appears:

The screenshot shows a web browser window titled 'Web Login'. It contains the following elements:

- A 'Username' label above a text input field containing the text 'Admin'.
- A 'Password' label above an empty password input field.
- A 'Remember Username' checkbox which is checked.
- A blue 'Log In' button.

4. Type in the default username (**Admin**) and password (**Admin**), and then click **Log In**.
5. Open the IP Interfaces table (**Setup** menu > **IP Network** tab > **Core Entities** folder > **IP Interfaces**).

6. Select the OAMP interface ('Application Type' with **OAMP + Media + Control**), click **Edit**, and then in the dialog box, modify the device's OAMP interface.

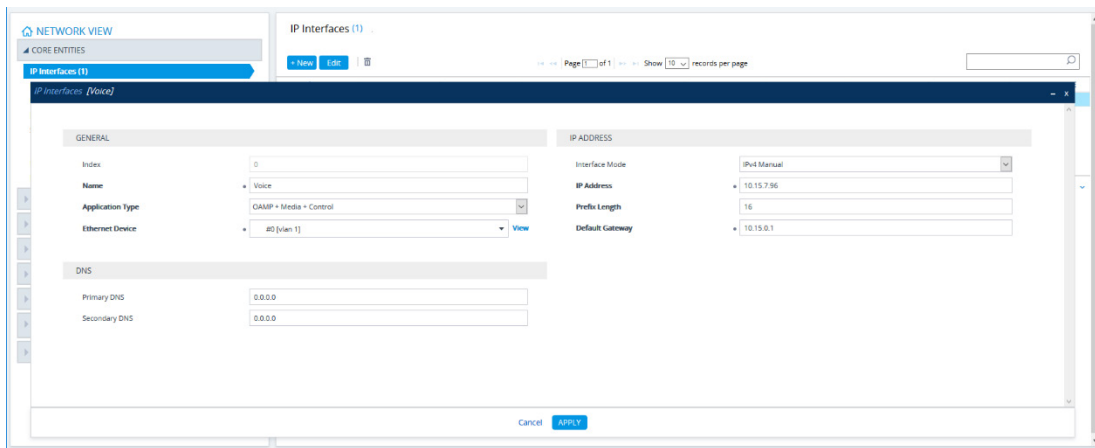

7. Click **Apply** to submit your changes; your connection with the device becomes unavailable at the default IP address (due to the new IP address).
8. Change the IP settings of your computer to correspond with the new OAMP IP addresses and subnet of the device.
9. Access the device again, but at its new IP address, and then on the Web interface's toolbar, click the **Save** button; the new IP address is now saved to the device's flash memory.
10. Re-cable the device to the required network. You can now access the device's management interfaces remotely, using the new IP address.

---

## Obtaining Documentation and Software

If you have a maintenance and support agreement with AudioCodes, you can download the device's latest software version from AudioCodes' Services Portal at <https://services.audiocodes.com> (registered users only).

You can also download additional documentation relating to the device (such as the *User's Manual* and *Hardware Manual*) from AudioCodes' website at <https://www.audiocodes.com/library/technical-documents?productGroup=1645>.

---

## Customer Support

Customer technical support and services are provided by AudioCodes or by an authorized AudioCodes Service Partner. For more information on how to buy technical support for AudioCodes products and for contact information, please visit AudioCodes website at <https://www.audiocodes.com/services-support/maintenance-and-support>.



---

## Safety Precautions

- This device is an indoor unit and therefore, must not be installed outdoors. Ethernet cabling must be routed only indoors and must not exit the building.
- The device must be installed and serviced only by qualified service personnel.
- Do not open or dismantle the device.
- Do not expose the device to water or moisture.
- Operate the device in an ambient temperature (T<sub>ma</sub>) that does not exceed 40°C (104°F).
- Make sure the device is installed in a well-ventilated location to avoid over heating of internal components and subsequent damage.
- Vacant chassis slots must be covered with slot covers (panels) to ensure proper airflow within the chassis.
- Do not place any object on top of the device. Make sure that sufficient clearance from the top and sides (left and right) are maintained to ensure proper airflow to avoid over heating of internal components. The side panels of the chassis where the air vents are located must remain unobstructed to ensure adequate airflow and prevent overheating of the chassis components.
- Do not operate the device without the two Fan Tray modules.
- Only modules supplied and approved by AudioCodes may be installed in the chassis slots.
- The device must be installed only in telecommunication sites in compliance with ETS 300-253 requirements "Earthing and Bonding of Telecommunication Equipment in Telecommunication Centers".
- The device must be installed only in restricted access locations.
- Operate the device only from the type of power source indicated on the chassis.
- Installation of the device must be in accordance with national wiring codes and conform to local regulations.
- Both Power Supply modules must be connected and each must be connected to a different power source. The two power sources must have the same ground potential.
- Use only the supplied AC power cords or DC power feed cables for connection to the power sources.
- The device must be connected to an electrical socket-outlet providing a protective earthing connection.

### **About AudioCodes**

AudioCodes Ltd. (NASDAQ, TASE: AUDC) is a leading vendor of advanced communications software, products and productivity solutions for the digital workplace. AudioCodes enables enterprises and service providers to build and operate all-IP voice networks for unified communications, contact centers, and hosted business services. AudioCodes offers a broad range of innovative products, solutions and services that are used by large multi-national enterprises and leading tier-1 operators around the world.

#### **International Headquarters**

1 Hayarden Street,  
Airport City  
Lod 7019900, Israel  
Tel: +972-3-976-4000  
Fax: +972-3-976-4040

#### **AudioCodes Inc.**

200 Cottontail Lane,  
Suite A101E,  
Somerset, NJ 08873  
Tel: +1-732-469-0880  
Fax: +1-732-469-2298

**Contact us:** <https://www.audiocodes.com/corporate/offices-worldwide>

**Website:** <https://www.audiocodes.com/>

©2020 AudioCodes Ltd. All rights reserved. AudioCodes, AC, HD VoIP, HD VoIP Sounds Better, IPmedia, Mediant, MediaPack, What's Inside Matters, OSN, SmartTAP, User Management Pack, VMAS, VoIPerfect, VoIPerfectHD, Your Gateway To VoIP, 3GX, VocaNom, AudioCodes One Voice, AudioCodes Meeting Insights, AudioCodes Room Experience and CloudBond are trademarks or registered trademarks of AudioCodes Limited. All other products or trademarks are property of their respective owners. Product specifications are subject to change without notice.

Document #: LTRT-42220  
Date Published: 02/09/2020

