

Mediant™ 600

VoIP Media Gateway

SIP Protocol

# Hardware Installation Manual



Version 6.4

July 2011

Document # LTRT-85608





---

## Table of Contents

---

<b>1</b>	<b>Introduction.....</b>	<b>7</b>
<b>2</b>	<b>Unpacking the Device .....</b>	<b>9</b>
<b>3</b>	<b>Physical Description .....</b>	<b>11</b>
3.1	Front Panel Description .....	12
3.1.1	FXS Module .....	13
3.1.1.1	Port Description .....	13
3.1.1.2	LED Description.....	13
3.1.2	FXO Module.....	14
3.1.2.1	Port Description .....	14
3.1.2.2	LED Description.....	14
3.1.3	BRI Module .....	15
3.1.3.1	Port Description .....	15
3.1.3.2	LED Description.....	15
3.1.4	TRUNKS (E1/T1) Module .....	16
3.1.4.1	Port Description .....	16
3.1.4.2	LED Description.....	16
3.1.5	CPU Module.....	17
3.1.5.1	Port Description .....	17
3.1.5.2	LED Description.....	18
3.2	Rear Panel Description .....	18
<b>4</b>	<b>Mounting the Device .....</b>	<b>19</b>
4.1	Desktop Mounting.....	19
4.2	19-Inch Rack Mounting.....	20
<b>5</b>	<b>Cabling the Device .....</b>	<b>21</b>
5.1	Grounding the Device .....	21
5.2	Connecting to the IP Network .....	22
5.3	Connecting to FXS Interfaces .....	22
5.4	Connecting to FXO Interfaces.....	23
5.5	Connecting the Analog Lifeline Phone .....	24
5.6	Connecting to ISDN BRI Lines.....	25
5.7	Connecting BRI Interfaces for PSTN Fallback .....	26
5.8	Connecting to E1/T1 Trunks .....	27
5.9	Connecting E1/T1 Trunks for PSTN Fallback.....	28
5.10	Connecting to Dry Contact Relay Alarm System.....	29
5.11	Connecting RS-232 Serial Interface to a Computer .....	30
5.12	Connecting to Power .....	31

---

## List of Figures

---

Figure 3-1: Front Panel.....	12
Figure 3-2: FXS Module.....	13
Figure 3-3: FXO Module .....	14
Figure 3-4: BRI Module.....	15
Figure 3-5: TRUNKS Module.....	16
Figure 3-6: CPU Module .....	17
Figure 3-7: Rear Panel.....	18
Figure 4-1: Underside of Device with Rubber Foot .....	19
Figure 4-2: Location of Grooves for Rubber Bumpers.....	19
Figure 4-3: Attaching the Mounting Ear Brackets.....	20
Figure 5-1: RJ-45 Connector Pinouts for Ethernet Network.....	22
Figure 5-2: RJ-11 Connector Pinouts for FXS.....	22
Figure 5-3: RJ-11 Connector Pinouts for FXO .....	23
Figure 5-4: RJ-11 Connector Pinouts for Analog Lifeline .....	24
Figure 5-5: Connecting the Analog FXS Lifeline .....	24
Figure 5-6: RJ-45 Connector Pinouts for BRI .....	25
Figure 5-7: PSTN Fallback for BRI Ports.....	26
Figure 5-8: RJ-48c Connector Pinouts for E1/T1 .....	27
Figure 5-9: PSTN Fallback for PRI E1/T1.....	28
Figure 5-10: Example of a Dry Contact Wires Mate .....	29
Figure 5-11: RS-232 Cable Adaptor .....	30

---

## List of Tables

---

Table 3-1: Front-Panel Description.....	12
Table 3-2: FXS Module LED Description.....	13
Table 3-3: FXO Module LED Description .....	14
Table 3-4: BRI Module LED Description.....	15
Table 3-5: E1/T1 PRI TRUNKS Module LED Description .....	16
Table 3-6: CPU Module Port Description.....	17
Table 3-7: CPU Module LEDs Description .....	18
Table 3-8: Rear-Panel Description .....	18
Table 5-1: Dry Contact Operational Description.....	29

## Notice

This Installation Manual describes the hardware installation for AudioCodes Mediant 600 SIP Voice-over-IP (VoIP) gateway.

Information contained in this document is believed to be accurate and reliable at the time of printing. However, due to ongoing product improvements and revisions, AudioCodes cannot guarantee accuracy of printed material after the Date Published nor can it accept responsibility for errors or omissions. Before consulting this document, check the corresponding Release Notes regarding feature preconditions and/or specific support in this release. In cases where there are discrepancies between this document and the Release Notes, the information in the Release Notes supersedes that in this document. Updates to this document and other documents as well as software files can be viewed by registered customers at <http://www.audiocodes.com/downloads>.

© Copyright 2011 AudioCodes Ltd. All rights reserved.

This document is subject to change without notice.

Date Published: October-01-2011

## Trademarks

AudioCodes, AC, AudioCoded, Ardito, CTI2, CTI<sup>2</sup>, CTI Squared, HD VoIP, HD VoIP Sounds Better, InTouch, IPmedia, Mediant, MediaPack, NetCoder, Netrake, Nuera, Open Solutions Network, OSN, Stretto, TrunkPack, VMAS, VoicePacketizer, VoIPerfect, VoIPerfectHD, What's Inside Matters, Your Gateway To VoIP and 3GX are trademarks or registered trademarks of AudioCodes Limited. All other products or trademarks are property of their respective owners.

## WEEE EU Directive

Pursuant to the WEEE EU Directive, electronic and electrical waste must not be disposed of with unsorted waste. Please contact your local recycling authority for disposal of this product.

## Customer Support

Customer technical support and service are generally provided by AudioCodes' Distributors, Partners, and Resellers from whom the product was purchased. For technical support for products purchased directly from AudioCodes, or for customers subscribed to AudioCodes Customer Technical Support (ACTS), contact [support@audiocodes.com](mailto:support@audiocodes.com).

## Abbreviations and Terminology

Each abbreviation, unless widely used, is spelled out in full when first used.

## Related Documentation

Document Name
Product Reference Manual
SIP Release Notes
Mediant 600 & Mediant 1000 SIP User's Manual

## General Notes



**Notes:** Throughout this manual and unless otherwise specified, the term *device* refers to the Mediant 600 gateway.

## Warnings and Safety Information



**Note:** The device is an **indoor** unit and therefore, must be installed **only** indoors.



### Caution Electrical Shock

Do not open or disassemble this device. The device carries high voltage and contact with internal components may expose you to electrical shock and bodily harm.



**Warning:** Disconnect the gateway from the mains and Telephone Network Voltage (TNV) before servicing.

# 1 Introduction

This document provides a hardware description of the Mediant 600 (hereafter referred to as *device*) and step-by-step procedures for cabling the device.



**Note:** For information on configuring the device, refer to the device's *User's Manual*.

## Reader's Notes



## 2 Unpacking the Device

Follow the procedure below for unpacking the carton in which the device is shipped.

➤ **To unpack the device:**

1. Open the carton and remove packing materials.
2. Remove Mediant 600 from the carton.
3. Check that there is no equipment damage.
4. Ensure that in addition to Mediant 600, the package contains the following items:
  - One AC power cable
  - Four anti-slide bumpers for desktop installation option
  - Two mounting brackets and four screws for 19-inch rack mounting
  - Two meter-length RS-232 DB-9 adaptor cable (for direct serial connection to a computer)
5. Check, retain and process any documents.

If there are any damaged or missing items, notify your AudioCodes sales representative.

**Reader's Notes**

## 3 Physical Description

The device is 1U high compact unit that can be installed in a 19-inch industrial rack. The device supports Basic Rate Interface (BRI), Primary Rate Interface (PRI) E1/T1, FXS, and FXO interfaces, and can be supplied in one of the following hardware configurations:

- 1 x E1/T1 port (can support also Fractional E1/T1)
- 2 x E1/T1 ports
- 4 x BRI ports (supporting up to 8 voice calls)
- 8 x BRI ports (supporting up to 16 voice calls)
- 4 x BRI ports and 1 x E1/T1 port
- 4 x BRI and 4 x FXS ports
- 4 x BRI and 4 x FXO ports
- 4 x FXS ports and 1 x E1/T1 port
- 4 x FXO ports and 1 x E1/T1 port

## 3.1 Front Panel Description

The device's front panel is shown in the figure below and described in the subsequent table.

**Figure 3-1: Front Panel**

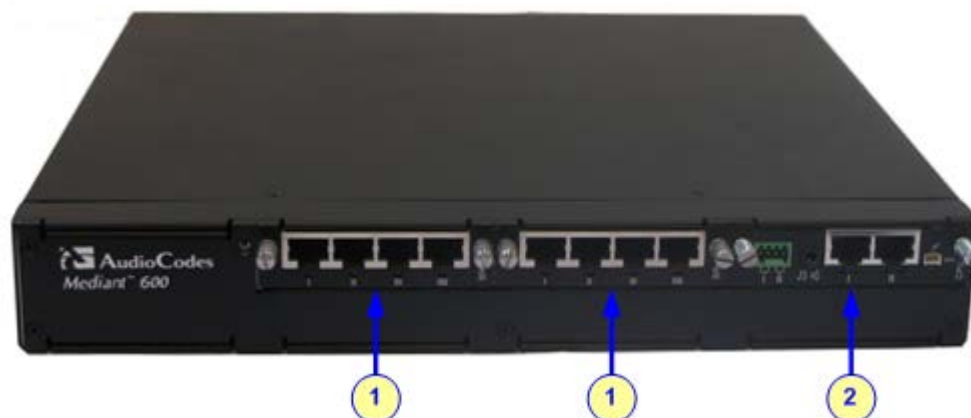

**Note:** The figure above is used only as an example. The number and type of interface modules depends on the ordered configuration.

**Table 3-1: Front-Panel Description**

Item #	Label	Component Description
1	<b>FXS</b>	(Optional) FXS module – see Section 3.1.1 on page 13 for a description.
	<b>FXO</b>	(Optional) FXO module – see Section 3.1.2 on page 14 for a description.
	<b>BRI</b>	(Optional) BRI module – see Section 3.1.3 on page 15 for a description.
	<b>TRUNKS</b>	(Optional) TRUNKS (E1/TE/J1) module – see Section 3.1.4 on page 16 for a description.
2	<b>CPU</b>	Central processing (CPU) module – see Section 3.1.5 on page 17 for a description.

### 3.1.1 FXS Module

The FXS module provides the Foreign eXchange Subscriber (FXS) interfaces. Up to two FXS modules can be installed in the device. Each FXS module can provide up to four FXS interfaces and therefore, the device can support up to eight FXS interfaces.

#### 3.1.1.1 Port Description

Each FXS module provides up to four RJ-11 ports. The ports are labeled I, II, III, and IIII.

**Figure 3-2: FXS Module**

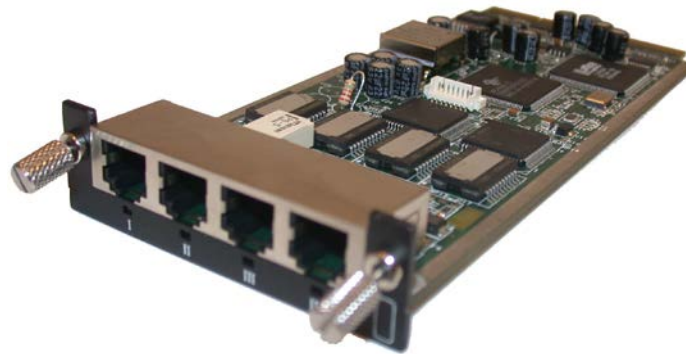

#### 3.1.1.2 LED Description

Each FXS port provides a LED for indicating operating status, as described in the table below:

**Table 3-2: FXS Module LED Description**

Color	State	Description
Green	On	Phone connected to the port is off-hooked.
	Blinking	Phone connected to the port rings.
Red	On	Error - malfunction in line or out of service due to Serial Peripheral Interface (SPI) failure.

## 3.1.2 FXO Module

The FXO module provides the Foreign eXchange Office (FXO) interfaces. Up to two FXO modules can be installed in the device. Each FXO module can provide up to four FXO interfaces and therefore, the device can support up to eight FXO interfaces.

### 3.1.2.1 Port Description

Each FXO module provides up to four RJ-11 ports. The ports are labeled **I**, **II**, **III**, and **IIII**.

**Figure 3-3: FXO Module**

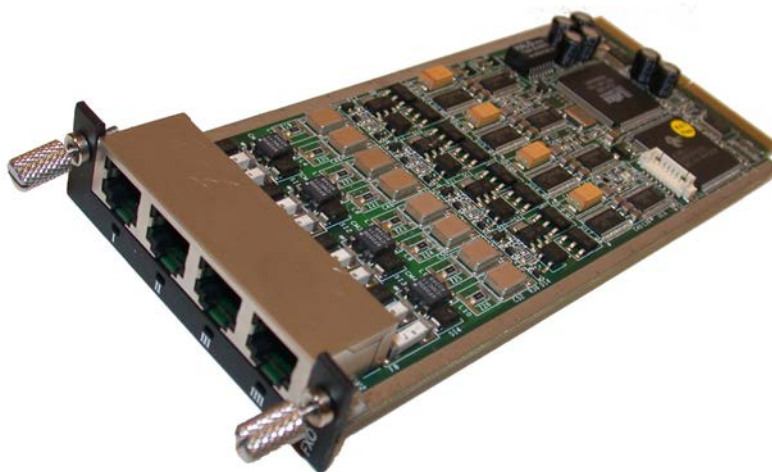

### 3.1.2.2 LED Description

Each FXO port provides a LED for indicating operating status, as described in the table below:

**Table 3-3: FXO Module LED Description**

Color	State	Description
Green	On	Off-hooks the line toward the PBX.
	Blinking	Detects a ring signal from the PBX.
Red	On	Error - malfunction in line or out of service due to Serial Peripheral Interface (SPI) failure.

### 3.1.3 BRI Module

The BRI module provides the Integrated Services Digital Network (ISDN), BRI interfaces. Up to two BRI modules can be installed in the device. Each BRI module can provide up to four BRI line interfaces and therefore, the device can support up to eight BRI interfaces.

#### 3.1.3.1 Port Description

Each BRI module provides up to four RJ-45 ports. The ports are labeled I, II, III, and IIII.

**Figure 3-4: BRI Module**

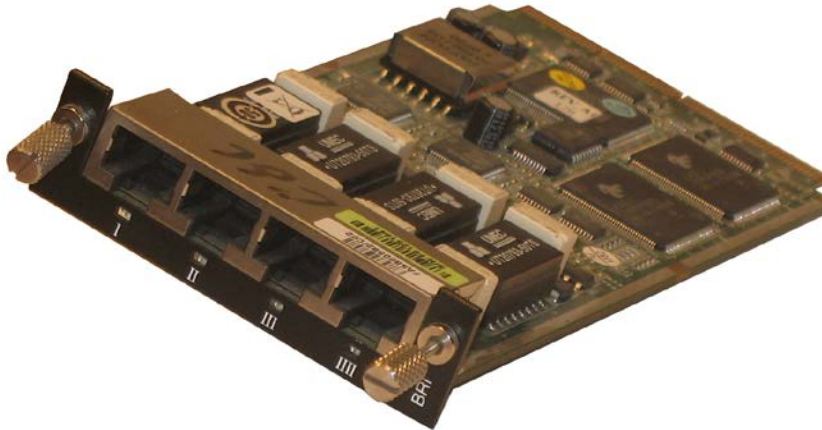

#### 3.1.3.2 LED Description

Each BRI port provides a LED for indicating operating status, as described in the table below:

**Table 3-4: BRI Module LED Description**

Color	State	Description
Green	On	Physical layer (Layer 1) is synchronized (normal operation).
Red	On	Physical layer (Layer 1) is not synchronized.
-	Off	BRI line is not active.

### 3.1.4 TRUNKS (E1/T1) Module

The device supports one or two digital PRI (E1/T1/J1) trunk spans, including fractional E1/T1.

#### 3.1.4.1 Port Description

The module is available in 1 or 2 span configurations, providing RJ-48c ports. The ports are labeled **I** and **II**.

**Figure 3-5: TRUNKS Module**

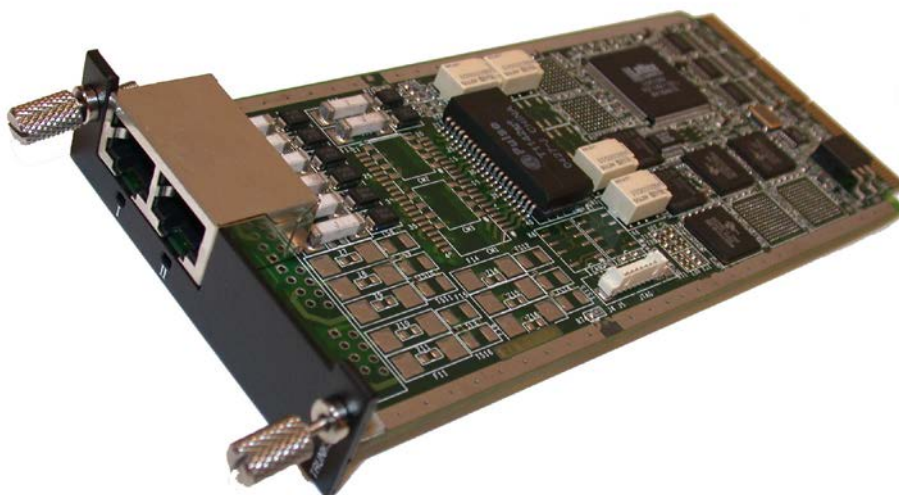

#### 3.1.4.2 LED Description

Each trunk port provides a LED for indicating operating status, as described in the table below:

**Table 3-5: E1/T1 PRI TRUNKS Module LED Description**

Color	State	Description
Green	On	Trunk is synchronized (normal operation).
Red	On	Loss due to any of the following signals: <ul style="list-style-type: none"> <li>▪ LOS - Loss of Signal</li> <li>▪ LOF - Loss of Frame</li> <li>▪ AIS - Alarm Indication Signal (the Blue Alarm)</li> <li>▪ RAI - Remote Alarm Indication (the Yellow Alarm)</li> </ul>
-	Off	Failure / disruption in the AC power supply or the power is currently not being supplied to the device through the AC power supply entry.



### 3.1.5 CPU Module

The CPU module is the central processing unit that provides various port interfaces.

#### 3.1.5.1 Port Description

The CPU module provides various port interfaces, as shown in the figure below and described in the subsequent table.

**Figure 3-6: CPU Module**

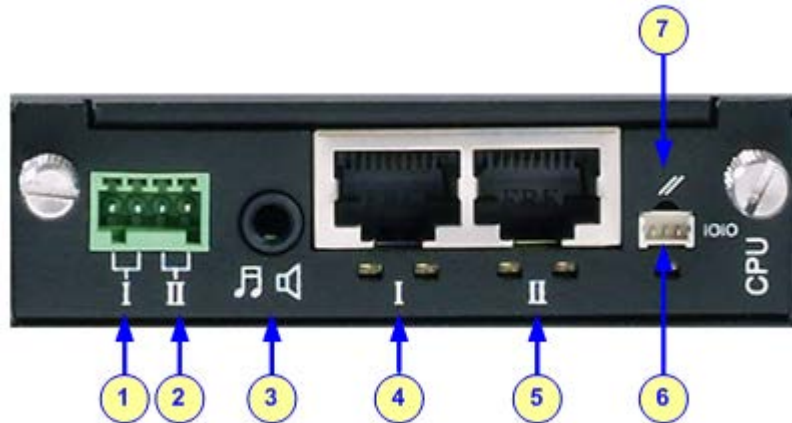

**Table 3-6: CPU Module Port Description**

Item #	Label	Component Description
1	I	Dry contact port (normally open), This port can be connected to an external audible or visual alarm system (e.g., bell, siren, hooter, or light).
2	II	Dry contact port (normally closed). This can be connected to an external audible or visual alarm system (bell, siren, hooter, or light).
3	♪	Audio IN/OUT. <b>Note:</b> This functionality will be supported in the next applicable release.
4	I	10/100Base-TX Ethernet port.
5	II	10/100Base-TX Ethernet port. <b>Note:</b> Two Ethernet ports provide Ethernet redundancy, protecting against failure such as a disconnection of any cable or associated LAN switch port.
6	IOIO	RS-232 port for accessing the CLI and for receiving error/notification messages. A 9-pin DB adapting cable is supplied.
7	//	Reset pinhole button for resetting the device or restoring the device to factory defaults (for more information, refer to the <i>User's Manual</i> ).

### 3.1.5.2 LED Description

The CPU module provides two LEDs for each of the Ethernet ports (located below the ports), as described in the table below:

**Table 3-7: CPU Module LEDs Description**

LED	Color	State	Description
Left LED	Orange	Blinking	Activity.
Right LED	Green	On	Link OK.
	Yellow	Blinking	Data is being received.
	-	Off	No link.

## 3.2 Rear Panel Description

The device's rear panel is shown in the figure below and described in the subsequent table.

**Figure 3-7: Rear Panel**



**Table 3-8: Rear-Panel Description**

Item #	Label	Component Description
1	100 - 240V 0.5A 50-60Hz	AC power supply entry plug.
2	ESD	Electrostatic Discharge (ESD) socket for attaching to an anti-static wrist strap and the ESD socket on the chassis.
3	⏏	Protective earthing screw.

## 4 Mounting the Device

The device can be mounted in one of the following ways:

- On a desktop – see Section 4.1 on page 19
- Installed in a standard 19-inch rack – see Section 4.2 on page 20

### 4.1 Desktop Mounting

The device can be mounted on a desktop, by attaching the supplied four adhesive, anti-slide rubber feet to the underside of the device. Once you have attached these rubber bumpers, you can place it on a desktop where the bumpers are in contact with the surface.

**Figure 4-1: Underside of Device with Rubber Foot**



➤ **To apply the anti-slide rubber bumpers to the device:**

1. Flip the device over so that its underside faces up.
2. Locate the four anti-slide grooves on the device's underside—one in each of the four corners, as shown in the figure below:

**Figure 4-2: Location of Grooves for Rubber Bumpers**



3. Peel off the adhesive, anti-slide rubber bumpers and stick one in each anti-slide groove.
4. Flip the device over again so that it is resting on its underside and the rubber bumpers are in contact with the surface.

## 4.2 19-Inch Rack Mounting

The device can be installed in a standard 19-inch rack.



### Rack Mount Safety Instructions

- **Elevated Operating Ambient Temperature:** If installed in a closed or multi-unit rack assembly, the operating ambient temperature of the rack environment may be greater than room ambient temperature. Therefore, consideration should be given to installing the equipment in an environment compatible with the maximum ambient temperature (T<sub>ma</sub>) of 45°C (113°F).
- **Reduced Air Flow:** Installation of the equipment in a rack should be such that the amount of air flow required for safe operation on the equipment is not compromised.
- **Mechanical Loading:** Mounting of the equipment in the rack should be such that a hazardous condition is not achieved due to uneven mechanical loading.
- **Circuit Overloading:** Consideration should be given to the connection of the equipment to the supply circuit and the effect that overloading of the circuits might have on over-current protection and supply wiring. Appropriate consideration of equipment nameplate ratings should be used when addressing this concern.
- **Reliable Earthing:** Reliable earthing of rack-mounted equipment should be maintained. Particular attention should be given to supply connections other than direct connections to the branch circuit (e.g., use of power strips.)

#### ➤ To mount the device in a 19-inch rack:

1. Ensure that you have a pre-installed rack shelf on which the device can be placed.
2. Attach the two mounting ear brackets (supplied) to each side of the device's chassis, using the supplied screws, as shown in the figure below:

Figure 4-3: Attaching the Mounting Ear Brackets

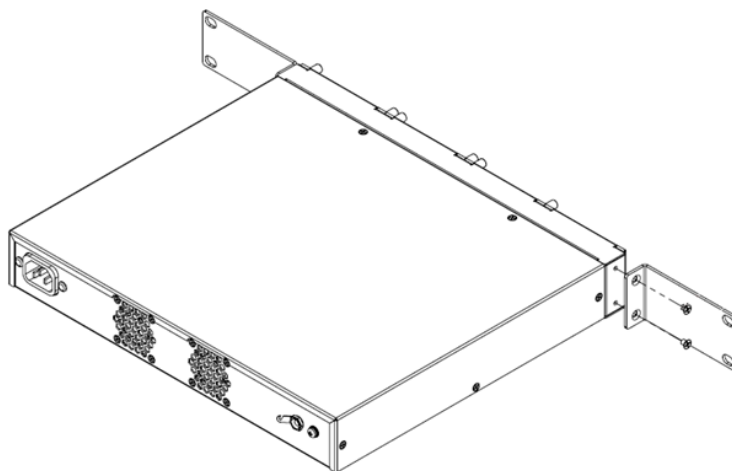

3. Place the device on a pre-installed shelf in the rack.
4. Attach the other end of the mounting brackets (that you installed in Step 2) to the vertical track of the rack's frame, using standard 19-inch rack bolts (not supplied).

## 5 Cabling the Device

This section describes how to cable the device:

- Connecting to earth or ground – see Section 5.1 on page 21
- Connecting to the LAN – see Section 5.2 on page 22
- Connecting to FXS interfaces – see Section 5.3 on page 22
- Connecting to FXO interfaces – see Section 5.4 on page 23
- Connecting to the analog FXS Lifeline telephone – see Section 5.5 on page 24
- Connecting to ISDN BRI lines – see Section 5.6 on page 25
- Connect BRI interfaces for PSTN Fallback – see Section 5.7 on page 26
- Connecting to E1/T1 trunks – see Section 5.8 on page 27
- Connecting E1/T1 trunks for PSTN Fallback – see Section 5.9 on page 28
- Connect the Dry Contact Relay Alarm System – see Section 5.10 on page 29
- Connecting to a computer for serial communication – see Section 5.11 on page 30
- Connecting to power – see Section 5.12 on page 31

### 5.1 Grounding the Device

The device must be permanently connected to earth (ground), using an equipment-earthing conductor.



#### Protective Earthing

The equipment is classified as Class I EN60950 and UL60950 and must be earthed at all times. The device must be permanently connected to the earth using the screw provided on the rear panel. Use 14-16 AWG wire and a proper ring terminal for the earthing.

**For Finland:** "Laite on liitettava suojavaadoituskoskettimilla varustettuun pistorasiaan."

**For Norway:** "Apparatet rna tilkoples jordet stikkontakt."

**For Sweden:** "Apparaten skall anslutas till jordat uttag."

The procedure below describes how to ground the device.

#### ➤ To ground the device:

1. Connect an electrically earthed strap of 16 AWG wire (minimum) to the chassis earthing screw (located on the rear panel), using the supplied washer.
2. Connect the other end of the strap to a protective earthing. This should be in accordance with the regulations enforced in the country of installation.

## 5.2 Connecting to the IP Network

The procedure below describes how to connect to the Ethernet (IP) network (e.g., switch). An RJ-45 cable connector with the following pinouts is used:

**Figure 5-1: RJ-45 Connector Pinouts for Ethernet Network**

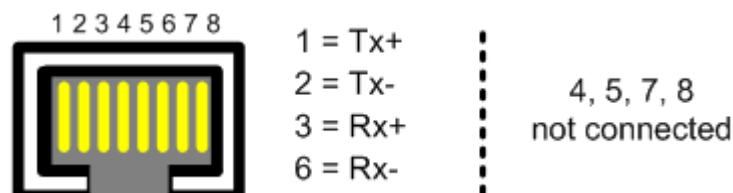

➤ **To connect the device to the Ethernet network:**

1. On the CPU module, connect the first Ethernet port (labeled **I**) directly to the Ethernet network, using a straight-through RJ-45 Ethernet cable.
2. Optionally, for Ethernet redundancy, connect the second Ethernet port (labeled **II**) to the Ethernet network.



**Note:** For Ethernet redundancy, it is recommended to connect each of the Ethernet ports to a different switch.

## 5.3 Connecting to FXS Interfaces

The procedure below describes how to connect to FXS interfaces (e.g., fax machines, modems, and plain old telephone system / POTS telephones).



**Warnings:**

- Ensure that FXS ports are connected to the appropriate external devices; otherwise, damage to the device may occur.
- The FXS ports are considered as TNV-2.



**Note:** This section is applicable only if your device is installed with an FXS module.

An RJ-11 cable connector with the following pinouts is used:

**Figure 5-2: RJ-11 Connector Pinouts for FXS**

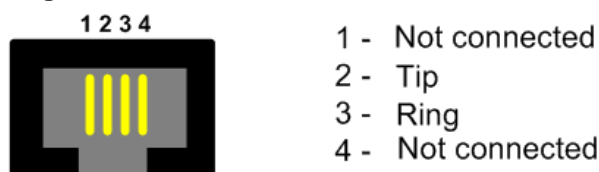

➤ **To connect to FXS interfaces:**

- Using an RJ-11 connector, connect the FXS port/s to the required telephone interface.

## 5.4 Connecting to FXO Interfaces

The procedure below describes how to connect the FXO port interfaces to telephone exchange analog lines or PBX extensions.

**Warnings:**

- To protect against electrical shock and fire, use a 26 AWG min wire to connect FXO ports to the PSTN.
- Ensure that FXO ports are connected to the appropriate external devices; otherwise, damage to the device may occur.
- FXO ports are considered as TNV-3.



**Note:** This section is applicable only if your device is installed with an FXO module.

An RJ-11 cable connector with the following pinouts is used:

**Figure 5-3: RJ-11 Connector Pinouts for FXO**

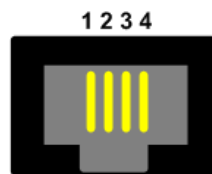

- 1 - Not connected
- 2 - Tip
- 3 - Ring
- 4 - Not connected

➤ **To connect to FXO interfaces:**

- Using an RJ-11 connector, connect the FXO port/s to the required telephone interface.

## 5.5 Connecting the Analog Lifeline Phone

The device supports an analog (FXS) Lifeline phone feature, whereby upon a power outage or IP network connectivity loss, IP calls are re-routed to the PSTN.

The analog Lifeline is provided by Port I on an FXS module. This port connects to the POTS phone and the PSTN or PBX, using a splitter cable. The splitter cable connects pins 1 and 4 to another source of an FXS port, and pins 2 and 3 to the POTS phone, as shown in the figure below:

**Figure 5-4: RJ-11 Connector Pinouts for Analog Lifeline**

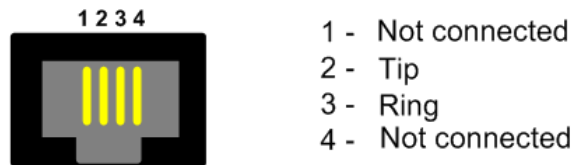

**Notes:**



- Analog Lifeline is supported only on FXS modules.
- An analog Lifeline can be setup for each FXS module installed in the chassis.
- The scenarios (i.e., power outage and/or IP network loss) upon which Lifeline is triggered is configured by the LifeLineType parameter. For more information, refer to the *User's Manual*.

➤ **To cable the analog Lifeline:**

1. Connect the Lifeline Splitter (supplied) to Port I on an FXS module.
2. Connect the Lifeline POTS phone to Port A on the Lifeline Splitter.
3. Connect an analog PSTN line to Port B on the Lifeline Splitter.

**Figure 5-5: Connecting the Analog FXS Lifeline**

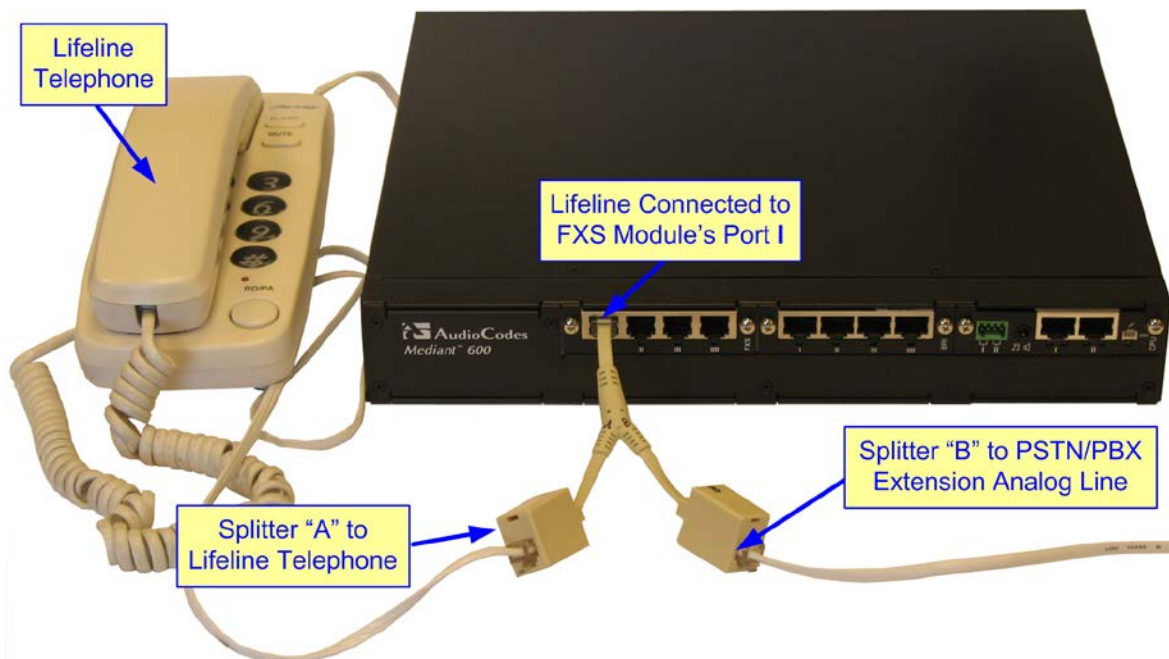



## 5.6 Connecting to ISDN BRI Lines

The procedure below describes how to connect to BRI lines.



**Warning:** To protect against electrical shock and fire, use a 26 AWG min wire to connect the BRI ports to the PSTN.



**Note:** This section is applicable only if your device is installed with a BRI module.

A BRI port can be configured either as TE (Termination Equipment/user side) or NT (Network Termination/network side). The connector pinouts vary according to the configuration, as shown below:

**Figure 5-6: RJ-45 Connector Pinouts for BRI**

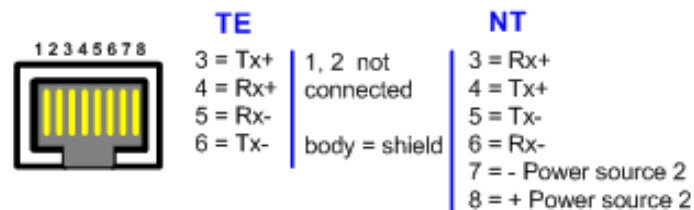

When configured as NT, the BRI port drives a nominal voltage of 38 V with limited current supply of up to 100 mA.

➤ **To connect to BRI lines:**

1. Connect the BRI cable to the device's BRI RJ-45 port.
2. Connect the other end of the cable to your ISDN telephone or PBX/PSTN switch.

## 5.7 Connecting BRI Interfaces for PSTN Fallback

The PSTN Fallback feature provides a BRI interface connection to the PSTN upon a power outage (i.e., Ethernet link failure). This allows a telephone or PBX connected to a BRI port to continue making calls through the PSTN network (instead of through the IP network).

The PSTN Fallback is provided by connecting adjacent BRI ports, where one port is connected to, for example, a PBX and its adjacent port is connected to an active PSTN line (i.e., normal operation, not only dedicated to Fallback). In the event of a power failure, a relay connects the adjacent BRI ports (i.e., ports I to II, and ports III to IIII) by the closing of a metallic switch inside the module.

Figure 5-7: PSTN Fallback for BRI Ports

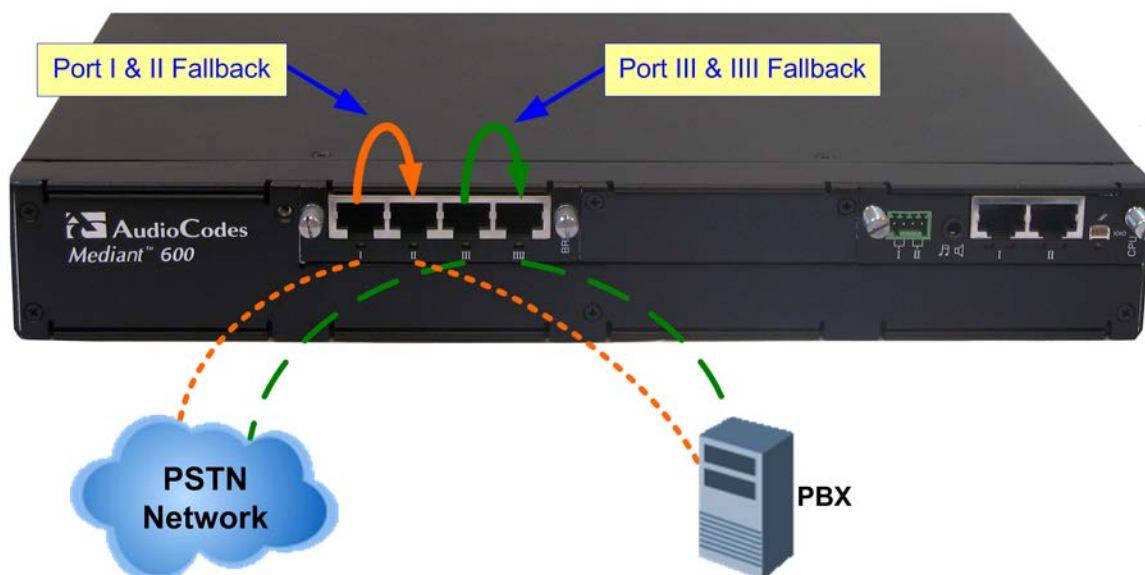

**Notes:**

- Damage can be caused to external equipment if PSTN Fallback is activated on two ports that are configured as user side.
- Ensure that paired BRI ports (i.e., ports I and II, and ports III and IIII) are not identically configured (i.e., one must be user the other net side); otherwise, PSTN Fallback does not function.

## 5.8 Connecting to E1/T1 Trunks

The procedure below describes how to connect to E1/T1 trunks.



**Warning:** To protect against electrical shock and fire, use a 26 AWG min wire to connect T1 or E1 ports to the PSTN.



**Note:** This section is applicable only if your device is installed with a TRUNKS module.

An RJ-48c trunk cable connector with the following pinouts is used:

**Figure 5-8: RJ-48c Connector Pinouts for E1/T1**

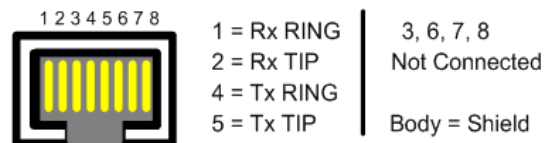

➤ **To connect the E1/T1 trunks:**

1. Connect the E1/T1 trunk cables to the device's RJ-48c ports.
2. Connect the other ends of the trunk cables to your PBX/PSTN switch.

## 5.9 Connecting E1/T1 Trunks for PSTN Fallback

The device supports PSTN Fallback feature when provided with two E1/T1 PRI spans. The digital module's Port II serves as a dedicated Fallback port connected to the PSTN. In the event of a power failure (i.e., no Ethernet link), a relay connects ports I and II by the closing of a metallic switch inside the module, re-routing trunk traffic from the PBX to the PSTN (instead of from the PBX to the IP network).

➤ **To connect the digital trunk interfaces for PSTN Fallback:**

- Connect Port I to the PBX, and Port II to the PSTN.

**Figure 5-9: PSTN Fallback for PRI E1/T1**

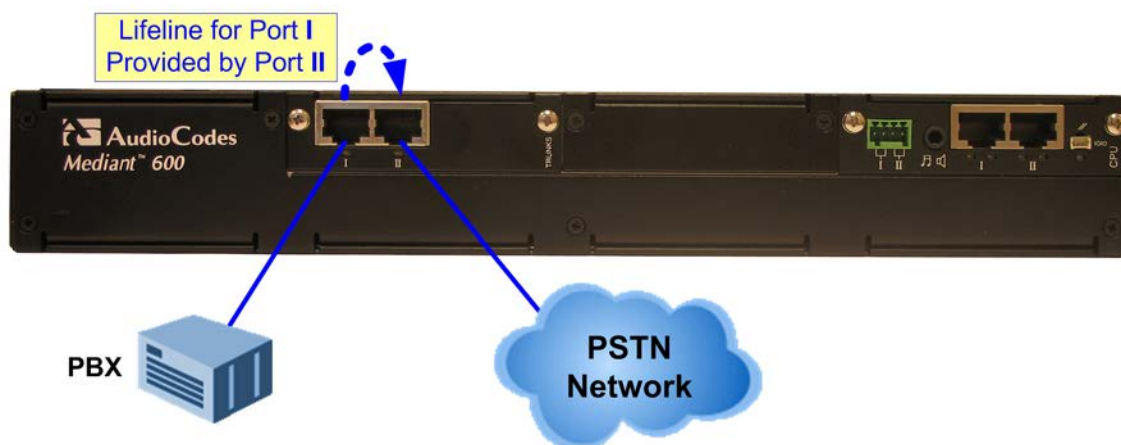

**Notes:**

- Only ISDN supports the PSTN Fallback feature when the number of supported channels (e.g., 30) is less than the maximum number of possible channels provided by the physical ports (e.g., two E1 trunks). When the number of supported channels (e.g., 60) equals the maximum number of channels provided by the physical ports (e.g., two E1 trunks), then other protocols such as CAS are also supported.
- This PSTN Fallback feature has no relation to the PSTN Fallback Software Upgrade Key.

## 5.10 Connecting to Dry Contact Relay Alarm System

The dry contact ports I and II located on the device's CPU module allows you to connect the device to an external audible or visual alarm system. The table below describes the operational status of these dry contact ports.

**Table 5-1: Dry Contact Operational Description**

Port	Normal State	Alarm Severity State
I	During normal operation, the dry contact is open.	If a Major alarm is generated, the dry contact closes.
II	During normal operation, the dry contact is closed.	If a Critical alarm is generated, the dry contact opens.

The external alarm system is connected to the device's dry contact connector on the CPU module, using a dry contact wires mate consisting of a four spring-cage terminal block connector (not supplied). The figure below shows an example of such a mate (labeled 4, 3, 2 and 1, from left to right). These connections correspond to the four pins of the dry contact connector on the CPU module.

**Figure 5-10: Example of a Dry Contact Wires Mate**

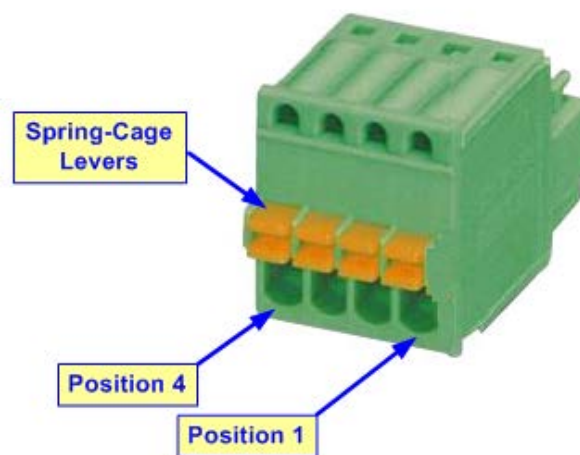

**Note:** It is recommended to use the dry contact mate of Phoenix Contact type FK-MC 0,5/ 4-ST-2,5, or any other vendor providing similar specifications.

You need to supply your own wiring (for connecting to the mate's spring-cage connections) as well as a visual and/or audible alarm system attached at the other end of the wires. The size of the cable gauge that connects to the dry contact ports must be in the range of 20 to 28 AWG. The dry contact system can receive a current of up to 1.5A. Its nominal switching capacity is 2A 30V DC.



**Note:** The dry contact alarm provided on the CPU must be connected only to SELV (Safety Extra-Low Voltage) non-energy hazard sources (Class 2) as per UL 60950 and EN 60950.

- **To set up a dry contact system:**
  1. Insert two wires into the mate's spring-cage wire connectors in position 4 and 3 for the device's dry contact Port I, and two wires in position 2 and 1 (for the device's dry contact Port II), by performing the following:
    - a. With a sharp, pointed object, press the position's corresponding orange button; the cage of the connection opens.
    - b. Insert the wire into the connector, and then release the orange button; the cage closes, securing the wire in place.
  2. Connect the other ends of the dry contact wiring to the alerts system (alarm, siren, or light) according to your preferences and requirements.

## 5.11 Connecting RS-232 Serial Interface to a Computer

The device's RS-232 interface port is used to access the CLI for serial communication and to receive error/notification messages. A 9-pin DB adaptor cable is supplied for connecting this port to a computer, as described in the procedure below.

**Figure 5-11: RS-232 Cable Adaptor**

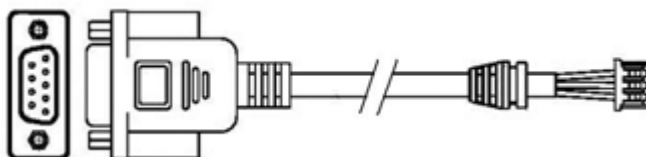

- **To connect the device's serial interface port to a computer:**
  1. Connect one end of the crossover RS-232 cable (supplied) to the device's RS-232 port (located on the CPU module and labeled **I0I0**).
  2. Connect the other end of the crossover RS-232 cable (i.e., the DB-9 connector) to either the COM1 or COM2 RS-232 communication port of your computer.



**Notes:**

- The RS-232 port is not intended for permanent connection.
- CLI configuration is currently not supported.

## 5.12 Connecting to Power

The device receives its power from a standard AC electrical outlet. The connection is made using the supplied AC power cord.

**Warnings:**

- Units must be connected (by service personnel) to a socket-outlet with a protective earthing connection.
- Use only the AC power cord supplied with the device.

➤ **To connect the device to the power supply:**

- Connect the 100-240V~50-60 Hz power socket, located on the device's rear panel, to a standard electrical outlet using the supplied AC power cord.



# Hardware Installation Manual

## Ver. 6.4