

## Quick Guide

### MediaPack 20x for BroadSoft's BroadCloud™ PacketSmart™ Monitoring

Version 4.4.5

Document #: LTRT-25314





---

## Table of Contents

---

<b>1</b>	<b>Before Installing .....</b>	<b>9</b>
<b>2</b>	<b>Cabling and Installing MP-20x .....</b>	<b>11</b>
<b>3</b>	<b>Configuring Network Parameters .....</b>	<b>13</b>
<b>4</b>	<b>Configuring the Device for PacketSmart.....</b>	<b>15</b>
4.1	Configuring PacketSmart through the Web Interface .....	15
4.2	Configuring PacketSmart through the CLI .....	18
4.3	Upgrading PacketSmart on the Fly .....	19
4.4	Accessing the PacketSmart Web Portal .....	20

---

## List of Figures

---

Figure 2-1: Cabling and Installing MP-20x .....	11
Figure 4-1: Login .....	15
Figure 4-2: PacketSmart Configuration .....	16
Figure 4-3: PacketSmart Login Screen .....	20
Figure 4-4: PacketSmart Web Portal – Selecting the Device.....	21

---

## List of Tables

---

Table 2-1: MP-20x LEDs Description .....12  
Table 4-1: PacketSmart Configuration Parameters Description .....17

**This page is intentionally left blank.**

## Notice

Information contained in this document is believed to be accurate and reliable at the time of printing. However, due to ongoing product improvements and revisions, AudioCodes cannot guarantee accuracy of printed material after the Date Published nor can it accept responsibility for errors or omissions. Updates to this document and other documents as well as software files can be viewed by registered customers at <http://www.audiocodes.com/downloads>.

© 2017 AudioCodes Inc. All rights reserved

This document is subject to change without notice.

Date Published: April-19-2017

## Trademarks

AudioCodes, AC, HD VoIP, HD VoIP Sounds Better, IPmedia, Mediant, MediaPack, What's Inside Matters, OSN, SmartTAP, User Management Pack, VMAS, VoIPerfect, VoIPerfectHD, Your Gateway To VoIP, 3GX, VocaNOM, AudioCodes One Voice and CloudBond are trademarks or registered trademarks of AudioCodes Limited. All other products or trademarks are property of their respective owners. Product specifications are subject to change without notice.

## WEEE EU Directive

Pursuant to the WEEE EU Directive, electronic and electrical waste must not be disposed of with unsorted waste. Please contact your local recycling authority for disposal of this product.

## Customer Support

Customer technical support and services are provided by AudioCodes or by an authorized AudioCodes Service Partner. For more information on how to buy technical support for AudioCodes products and for contact information, please visit our Web site at [www.audiocodes.com/support](http://www.audiocodes.com/support).

## Abbreviations and Terminology

Each abbreviation, unless widely used, is spelled out in full when first used.

## General Notes, Warnings, and Safety Information



**Note:** Open source software may have been added and/or amended for this product. For further information please visit our Web site at: <http://audiocodes.com/support> or contact your AudioCodes sales representative.



**Warning:** Before connecting MP-20x to power:

- Use only the AC/DC power adapter supplied with MP-20x. Do not use any other power adapter. This power adapter is a 12 VDC +/-10%, tolerance, 2A, limited power source wall-mount Class II power supply adapter.
- Ensure that the VAC ratings match.
- Ensure that you have read the Regulatory Information, obtained from [www.audiocodes.com/library](http://www.audiocodes.com/library).



**Warning:** The **Phone 1** and **Phone 2** ports are not specifically designed for 3-wire-connected equipment. 3-wire-connected equipment might not respond to incoming ringing when attached to these ports.

### For Customers in Canada:

This Class [B] digital apparatus complies with Canadian ICES-003.

Cet appareil numérique de la classe [B] est conforme à la norme NMB-003 du Canada.

The County Code Selection feature is disabled for products marketed in the US/Canada.

## Document Revision Record

LTRT	Description
25312	Initial document release.
25313	Changes made to PacketSmart chapter.
25314	Changes made to PacketSmart Configuration section.

## Documentation Feedback

AudioCodes continually strives to produce high quality documentation. If you have any comments (suggestions or errors) regarding this document, please fill out the Documentation Feedback form on our Web site at <http://www.audiocodes.com/downloads>.



# 1 Before Installing

Congratulations on purchasing your AudioCodes MediaPack 20x. Before you begin using the device, make sure that the following items are included in the shipped box:

- AudioCodes' MP-20x
- A 12V AC/DC power cord adaptor (use only supplied)
- You'll also need (not supplied by AudioCodes):
- A broadband Internet connection
- Analog telephones
- A personal computer
- RJ-11 telephone cables
- Two RJ-45 Ethernet cables

**This page is intentionally left blank.**

## 2 Cabling and Installing MP-20x

The procedure below describes how to cable and install the MP-20x to enable BroadCloud PacketSmart monitoring.

➤ **To cable and install MP-20x:**

1. Connect the MP-20x's Ethernet connector labeled **WAN** to your router, using the Ethernet cable.

**Figure 2-1: Cabling and Installing MP-20x**

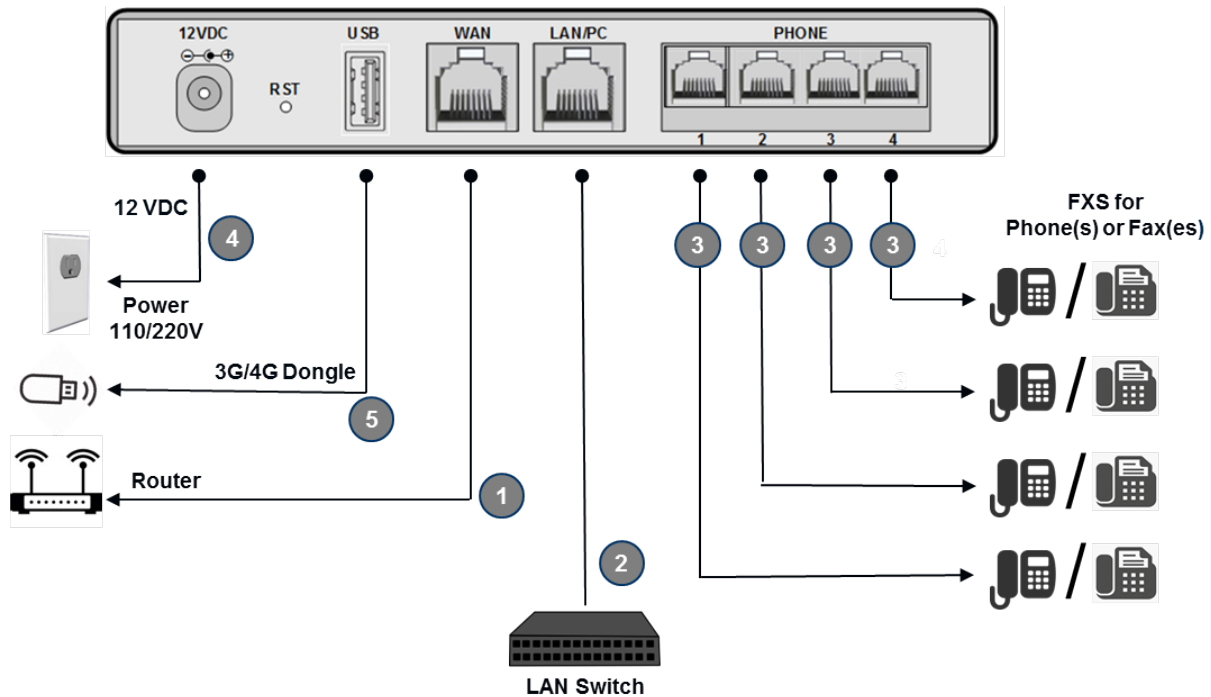

2. Connect the MP-20x's Ethernet connector labeled **LAN/PC** to your LAN Switch, using the second Ethernet cable. This connection requires configuring the switch to a mirrored port connected to the LAN port on the MP-20x.
3. If the device also supports analog phones, connect the MP-20x's telephone ports labeled **PHONE** to analog telephones/faxes, using the RJ-11 telephone cables.
4. Connect MP-20x to a standard 110/220 VAC electrical wall outlet, using the AC/DC power adapter; the **POWER** LED is lit (green) and when initialization completes (~ 1 minute), the **STATUS** LED changes from red to green.
5. The USB port can be used as a secondary WAN (with 3G/4G dongles) or to connect a disk-on-key, external hard disk drive or printer.

MP-20x provides LEDs on the front panel for indicating various operating status, as described in the table below:

**Table 2-1: MP-20x LEDs Description**

LED	Color	State	Description
POWER	Green	On	Power received by MP-20x
	-	Off	MP-20x has been powered off
STATUS	Green	On	System start-up successful
	Red	On	Reboot (automatic, by default)
PHONE 1- 4	Green	Type 1 Blinking	Idle Proxy register ok
		On	Off-hook
	Green	Type 2 Blinking	Phone ringing
		Type 3 Blinking	Upgrade in process (all LEDs including STATUS LED)
	Red	On	Idle Proxy register failed
	-	Off	On-hook and not ringing, not using Proxy
LAN / WAN	Yellow	Steady On	Connected at 10 Mbps
		Steady On	Connected at 100 Mbps
		Blinking	Activity - there is traffic on 10/100 Mbps
	Green	Steady On	Connected at 1000 Mbps
		Blinking	Activity - there is traffic on 1000 Mbps
	-	Off	Disconnected
USB	Green	On	USB device is connected
	-	Off	No USB device is connected

## 3 Configuring Network Parameters

The procedure below describes how to configure the Network parameters.

➤ **To configure network parameters:**

1. On your PC, verify that the Local Area Connection status is 'Connected', by clicking **Start > Settings > Network Connections**, and then double-clicking the **Local Area Connection** icon.
2. If the LAN status displays "Disconnected", click **Properties**, select 'Internet Protocol (TCP/IP)', and then click **Properties**; ensure that the 'Obtain an IP address automatically' option is selected.
3. Open a Web browser and enter the MP-20x IP address or the hostname (by default **192.168.2.1**) to access the Web-based management interface; the 'Login' screen is displayed. The MP-20x embedded Web server's Welcome screen is displayed.



**Note:** When working in "Bridge" mode, in order to find the device's IP address, use the Voice menu. Refer to the Voice Menu Guidelines section in *LTRT-50614 MP-20x Telephone Adapter User's Manual*.

4. Define a new password (record and retain it for future reference).
5. In the Quick Setup page, select the Internet connection method. Consult with your ISP for the required connection type (DHCP, PPPoE, or PPTP), and then click **OK**. The Network map displays the elements connected to MP-20x.



**Note:** If there is no Internet connection, a red "X" appears below the globe icon on the MP-20x Web server's Home page. Consult with your ISP for valid connection parameters.

**This page is intentionally left blank.**

## 4 Configuring the Device for PacketSmart

The device can be configured for PacketSmart through the Web interface or the CLI.



**Note:** PacketSmart is only applicable to **MP-202R** and **MP-204R** devices.

### 4.1 Configuring PacketSmart through the Web Interface

This section shows how to configure PacketSmart through the Web interface.

➤ **To configure PacketSmart through the Web interface:**

1. Open a Web browser on your PC.
2. Log in to the MP-20x's embedded Web interface: With your PC connected directly to the MP-20x, open a Web browser and enter "**192.168.2.1**" to access the Web-based management interface; the 'Login' screen is displayed.

**Figure 4-1: Login**

Language:

User Name:

Password (case sensitive):   Show password

3. In the 'User Name' field, enter your user name (Default: **admin**)
4. In the 'Password' field, enter your case-sensitive password (Default: **admin**)
5. Click the **Continue >** button.
6. In the Advanced screen, click the **PacketSmart Configuration** icon ; the PacketSmart Configuration screen opens.

**Figure 4-2: PacketSmart Configuration**



### PacketSmart Configuration

<input checked="" type="checkbox"/> Enabled	
PacketSmart SW Version:	CLM-7.3.0-R2289
PacketSmart ID:	AUDC_MP204_000000000000
PacketSmart Platform:	MP204
PacketSmart Server IP:	packetsmartusa.broadsoft.co Port 443
Monitoring Interface:	WAN Ethernet ▼
Network Interface:	Bridge ▼

Click the **Refresh** button to update the status.

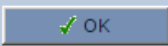
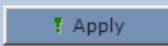
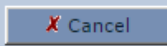
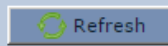

7. Use the table below as reference when configuring PacketSmart.

**Table 4-1: PacketSmart Configuration Parameters Description**

Parameter	Description
Enabled	Select this option to enable the embedded PacketSmart probe software. <ul style="list-style-type: none"> <li>• <b>Disabled</b> (Default)</li> <li>• <b>Enabled</b></li> </ul>
PacketSmart SW Version	(Read-only) Displays the PacketSmart probe software version.
PacketSmart ID	(Read-only) Displays the PacketSmart probe software on the PacketSmart server in the following format: <b>AUDC_&lt;model_name&gt;_&lt;MAC_address&gt;</b> Example: <b>AUDC_MP204_&lt;MAC_address&gt;</b> where <b>MP204</b> is the device Make sure the MAC address is correct.
PacketSmart Platform	(Read-only) Defines the device name.
PacketSmart Server IP	Defines the IP address of the PacketSmart server to which the PacketSmart probe software connects.
PacketSmart Port	Defines the TCP port of the PacketSmart server to which the PacketSmart probe software connects. <ul style="list-style-type: none"> <li>▪ Port 80 – for an HTTP connection</li> <li>▪ Port 443 – for an HTTPS connection (secured)</li> </ul>
Monitoring Interface	Defines the Interface to be monitored by PacketSmart probe software. Default: <b>WAN Ethernet</b>
Network Interface	Defines the interface through which the analyzed traffic is sent to the PacketSmart server. Default: <b>WAN Ethernet</b>
Configuration Server URL	Defines the address of the new PacketSmart firmware file. <b>Note:</b> This parameter does not appear in the Web interface. It can only be modified through the CLI. See Section 4.3 on page 19 for more information.
Upgrade Needed	This parameter is used to immediately upgrade PacketSmart. Possible values: <ul style="list-style-type: none"> <li>▪ 1 - Immediately upgrade</li> <li>▪ 0 – Do not upgrade</li> </ul> <b>Note:</b> After PacketSmart has been upgraded, this parameter is automatically set to "0". *

8. Click **OK**.

## 4.2 Configuring PacketSmart through the CLI

You can alternatively configure PacketSmart through the device's Command Line Interface (CLI).

➤ **To configure PacketSmart through the CLI:**

1. Open a Telnet connection to the MP-20x device (Default: **telnet 192.168.2.1**)
2. Log in with administrator privileges (Default: **admin/admin**)
3. Run the following commands under the **MP20x>** prompt:

```
conf set "packetsmart/enabled" "1";
conf set "packetsmart/packetsmart_server_ip" "<URL>"
conf set "packetsmart/packetsmart_server_port" "<Port>"
conf set "packetsmart/configuration_upgrade_server_url"
"<URL>"
conf set "packetsmart/monitor_interface" "eth1"
conf set "packetsmart/network_interface" "br0"
conf reconf 1
```

## 4.3 Upgrading PacketSmart on the Fly

It is now possible to automatically upgrade PacketSmart by either:

- Changing the `configuration_upgrade_server_url` parameter in the configuration file on the Device Management server (DMS)
- Running CLI command.

➤ **To upgrade PacketSmart by changing the parameter:**

1. Change the `configuration_upgrade_server_url` parameter on DMS server. (e.g., change `configuration_upgrade_server_url=https://XX.XX.XX.XX/psmart.tar.gz` to `configuration_upgrade_server_url=https://XX.XX.XX.XX/newpsmart.tar.gz`).
2. The device will download a new configuration file during the next periodic check or after a manual reboot.
3. After downloading the configuration, the system checks if the PacketSmart `configuration_upgrade_server_url https://XX.XX.XX.XX/newpsmart.tar.gz` parameter has changed. If so, the device downloads an updated `tar.gz` file from the Configuration Upgrade Server URL to the device. The URL can either be **HTTP** or **HTTPS**. This check takes place during the boot process, after the `configuration_upgrade_server_url` parameter has changed.

➤ **To upgrade PacketSmart through the CLI:**

1. Open a Telnet connection to the MP-20x device (Default: Telnet 192.168.2.1).
2. Log in with administration privileges (Default: admin/admin).
3. Run the following commands under the **MP20x>** prompt:

```
conf set packetsmart/configuration_upgrade_server_url
http://xx.xx.xx.xx/newpacketsmart.tar.gz

conf set packetsmart/upgrade_needed 1
conf reconf 1
```

4. PacketSmart will be upgraded after 30 seconds.

## 4.4 Accessing the PacketSmart Web Portal

This section shows how to access BroadSoft's PacketSmart Web Portal and find analyzed information.

➤ **To access the PacketSmart Web Portal:**

1. Open a Web browser and in the URL field, enter <https://packetsmart.broadsoft.com/dashboard/>
2. In the PacketSmart Login screen that opens, enter the required fields and then click the **Login** button.

**Figure 4-3: PacketSmart Login Screen**

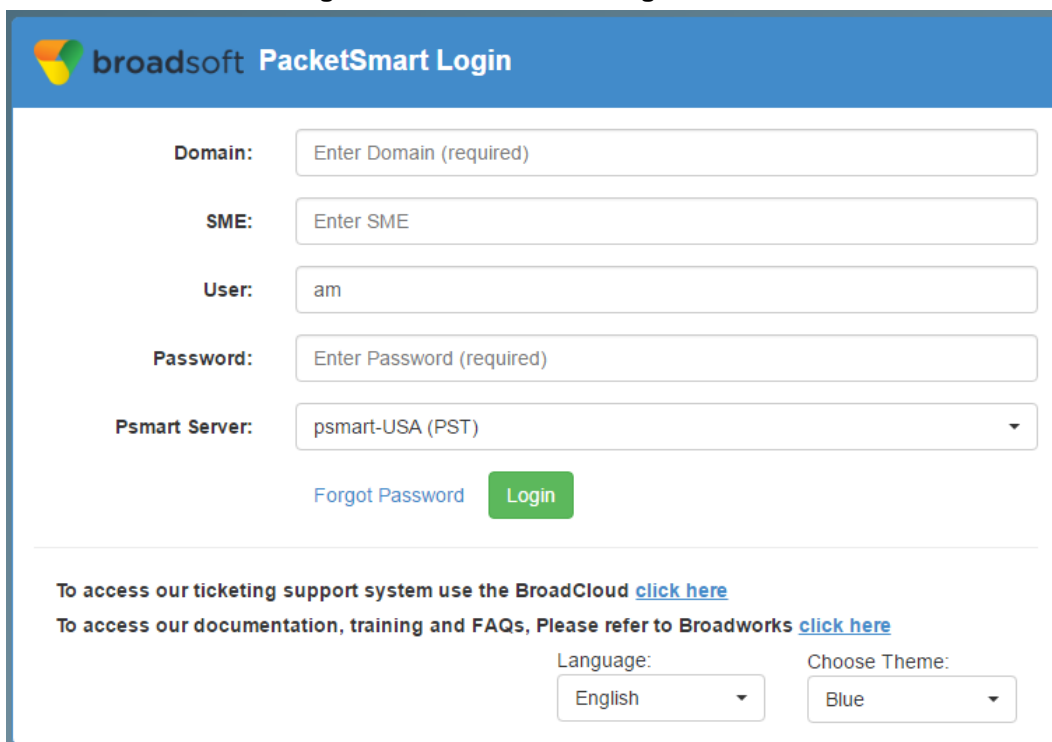

**broadsoft PacketSmart Login**

**Domain:** Enter Domain (required)

**SME:** Enter SME

**User:** am

**Password:** Enter Password (required)

**Psmart Server:** psmart-USA (PST)

[Forgot Password](#) **Login**

To access our ticketing support system use the BroadCloud [click here](#)

To access our documentation, training and FAQs, Please refer to Broadworks [click here](#)

Language: English

Choose Theme: Blue

➤ **To view records:**

1. In the main landing page, you'll view multiple window sections.
2. From the menu on the left, select the diagnosis type, e.g., Call Metrics, Signaling Records, Traffic Flows, etc.
3. Select PacketSmart **SME** and the associated device under **Display Name (Device)**; then define the time period and click **Show Data**.

**Figure 4-4: PacketSmart Web Portal – Selecting the Device**

Select SME and Device

SME:	<input type="text" value="_UNASSIGNED_"/>	<input type="text" value="07/11/2016 08:41"/>	<input type="button" value="Show Data"/>
Display Name (Device):	<input type="text" value="AUDC_MP204_00908F7F66E1"/>	<input type="text" value="07/12/2016 08:41"/>	<input type="button" value="Show Data"/>

Device Type:PACKETPRO, Last Contact Time:2016/7/12 08:41:41 America/Chicago, Version:CLM-7.2.0-R2221, IP:192.168.8.11, CIP:192.168.8.11, Mode:2, SIP PORT:5060



**Note:** Active devices are indicated with a green tick.

For more information, visit the PacketSmart Help website:  
<https://packetsmart.broadsoft.com/help/>

## Quick Guide

### MediaPack 20x for BroadSoft's BroadCloud™ PacketSmart™ Monitoring

Version 4.4.5

Document #: LTRT-25314



[www.audiocodes.com](http://www.audiocodes.com)