

# AudioCodes Quick Reference Guide

## Serial/console access for AudioCodes

### Background:

This quick reference guide explains the different serial cables use for various AudioCodes devices

In most cases with most PCs and Laptops you'll require a USB to serial converter.

While not supplied by AudioCodes these would be widely available.

### Serial Adapter for laptop/PC (not provided by AudioCodes)



## Cables for various AudioCodes Gateways, SBC and modules

### MP1xx Analog Gateways

**Note:** MP-112 does not provide a serial port.

CABLE ADPT PS-2 MALE to DB-9 FEMALE 2.5m

Part# RCBA10004



**Note:** MP-112 does not provide a serial port.

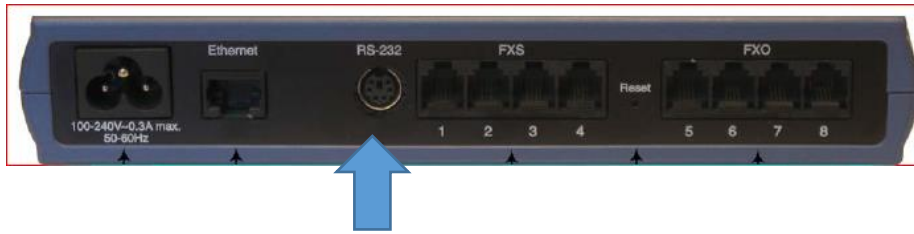

RS-232 status port (requires a DB-9 to PS/2 adaptor).

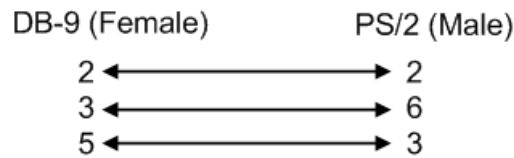

2 (TD) - Transmit Data  
 3 (GND) - Ground for Voltage  
 6 (RD) - Receive Data

Establish serial communication with the device using a terminal emulator program (such as PuTTY or HyperTerminal) with the following communication port settings:

- Baud Rate: 9,600 bps for MP-11x
- Data Bits: 8
- Parity: None
- Stop Bits: 1
- Flow Control: None

### MP-124 Analog Gateways

MP124 newer models (MP124E) RJ45-DB9 female. The same serial cable as our OSN 3.

The same pin-out as the “baby blue” RJ45 that ships with many cisco routers and switches.

CABLE ASSY OSN3 SERIAL CABLE RJ-45 TO DB-9F      Part# RCABY0042



**MP-124D** models DB9 male -DB9 female “straight through” extension of the USB adapter. Indeed, the USB adapter will work if the housings are not in the way. While not available for purchase at AudioCodes, many suppliers can be found on the www: DB9 Male to Female Straight-Thru Extension / Serial Cable.

- Baud Rate: 115,200 bps for MP-124D with DB 9 connector
- Baud Rate: 9600 bps for MP-124E with the RJ45 connector
- Data Bits: 8
- Parity: None
- Stop Bits: 1
- Flow Control: None

**DB-9 Connector Pinouts for Serial Interface (MP124D)**

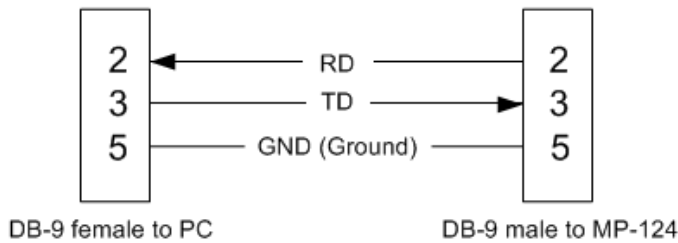

**MP124E and MP1288**

CABLE ASSY OSN3 SERIAL CABLE RJ-45 TO DB-9F (Part # RCABY0042)

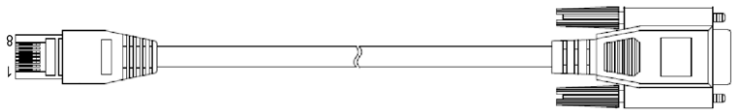

**RJ-45 to DB-9 Serial Cable Connector Pinouts RJ-45**

- 1
- 2
- 3
- 4
- 5
- 6
- 7
- 8

**DB-9 Female**

- 8
- 6
- 2
- 5
- 5
- 3
- 4
- 7

## MP-124E

Baud Rate: 9600 bps for MP-124E with the RJ45 connector

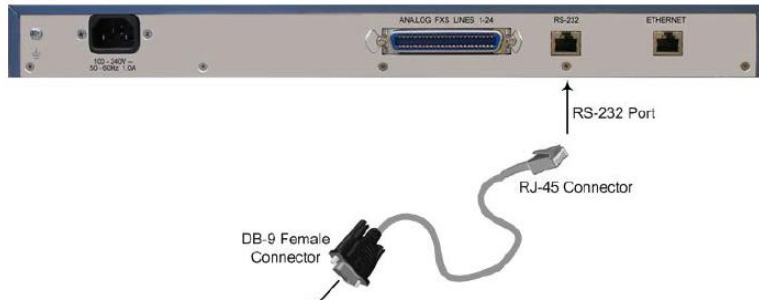

## MP1288

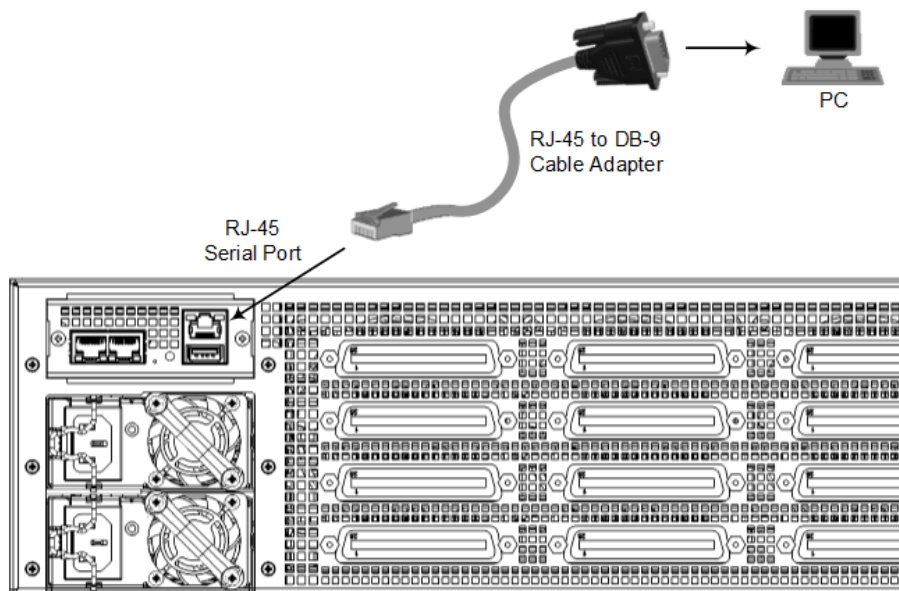

Baud Rate: 115,200 bps

- Data Bits: 8
- Parity: None
- Stop Bits: 1
- Flow Control: None

## MP-20x Analog Gateways

No serial connection available

## Digital Gateways and SBCs

### Mediant 1000B/ Mediant 800 Digital Gateway

CABLE ASSY CONSOLE,  
RS-232 for RMX-1 Use the “Red” interface

RCABY0018

M800/M1KB



**Older Mediant 800 may have the RJ45 console interface where the same cable pinout as the M500 Single RJ-45 to Dtype9 serial cable for Mediant 500.**

CABLE ASSY OSN3 SERIAL CABLE RJ-45 TO DB-9F Part # RCABY0042

RJ-45	Pin	Signal
1		Not used
2		Ground (GND)
3		Transmit Data (TXD)
4		Not used
5		Not used
6		Receive Data (RXD)
7		Ground (GND)
8		Not used

**Mediant 500 uses the same cable the MP-124E and OSN3 module**

CABLE ASSY OSN3 SERIAL CABLE RJ-45 TO DB-9F      RCABY0042

### Mediant 1000B Digital Gateway

CABLE ASSY CONSOLE,  
RS-232 for RMX-1 (use the “Red”  
interface)

RCABY0018

M800/M1KB



### (Medinat 1000 gateway (discontinued 2008

CABLE ASSY  
RS-232 CABLE FOR M1000

RCBZ10009

M1000



### Mediant 2000 Digital Gateway

There is no native serial port. An additional module card was orderable for the first generation but was likely used for an SMDI (Voicemail) link. When the RS-232 connection is used for SMDI messages (Serial SMDI), it cannot be used for other applications, for example, to access the Command Line Interface (CLI).

### Mediant 3000 - [8410 and/or 6310]

CABLE RS-232, 2m w/ MICRO-MINIATURE CONN

RCBZ10012

M3K/8410/6310



### Mediant 4000 and Mediant 2600

CABLE ASSY MICRO USB 5P MALE TO DUAL DB-9F  
(use the Red interface

RCABY0049

M4K



### Medinat 5000 and Mediant 8000 High density

The SC board provides Mini DIN 8 COM RS-232 serial port connector on its front panel that may be used for accessing board's Command Line Interface (CLI). Alternatively, RS-232 serial port connector on the SA/RTM module may be used for accessing the SC boards' CLI.

SA/RTM board's RS-232 console port is a 9-pin female D-type connector (P2). The corresponding cable is a straight through cable with a 9-pin male D-type connector. While not available for purchase at AudioCodes, many suppliers can be found on the www: DB9 Male to Female Straight-Thru Extension / Serial Cable.

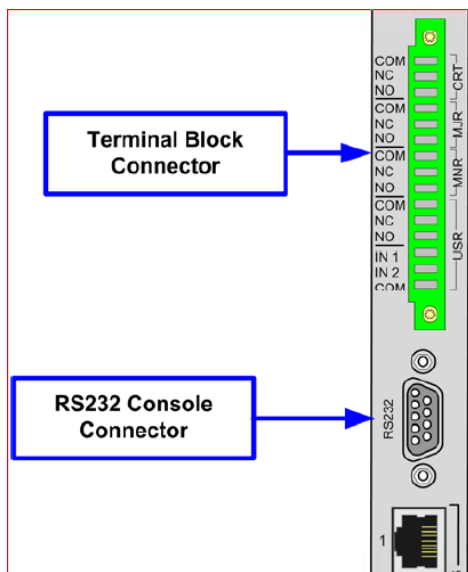

#### RS-232 Serial Connection Properties

<b>Bits per second</b>	<b>9600</b>
<b>Data bits</b>	<b>8</b>
<b>Parity</b>	<b>None</b>
<b>Stop bits</b>	<b>1</b>
<b>Flow control</b>	<b>None</b>

**Medinat 5000 and Mediant 8000 (continued)**

Older SC Board Mini DIN 8 Serial Port Connector

While no longer available for purchase at AudioCodes many resources can be found on the [www](http://www): MiniDin8 Pin Male to DB9 Female. Serial Connection Cable

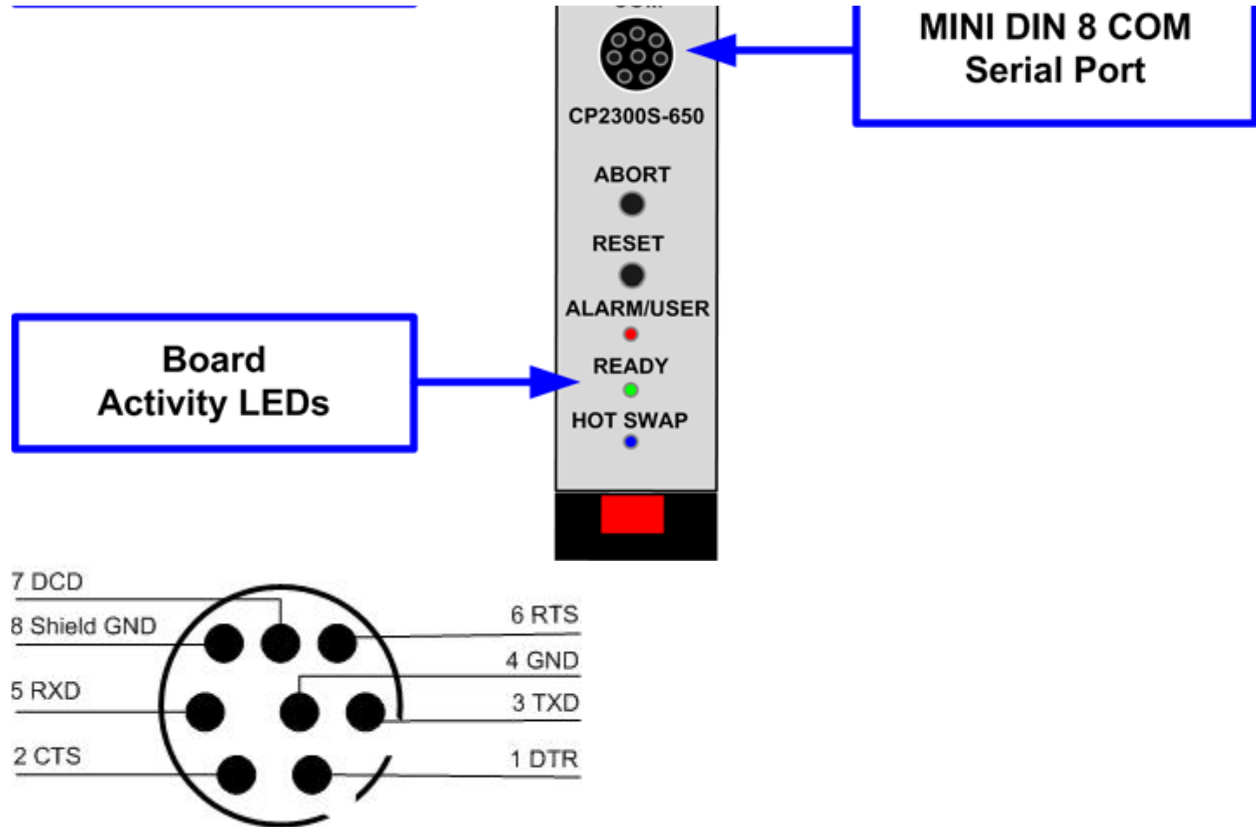



### Mediant 9000 (HP Proliant platform)

To perform initial configuration, display and keyboard are required.

- Connect the display to the 15-pin HD D-Sub (HD-15) VGA port on the Mediant 9000.
- Connect the keyboard to the USB port.

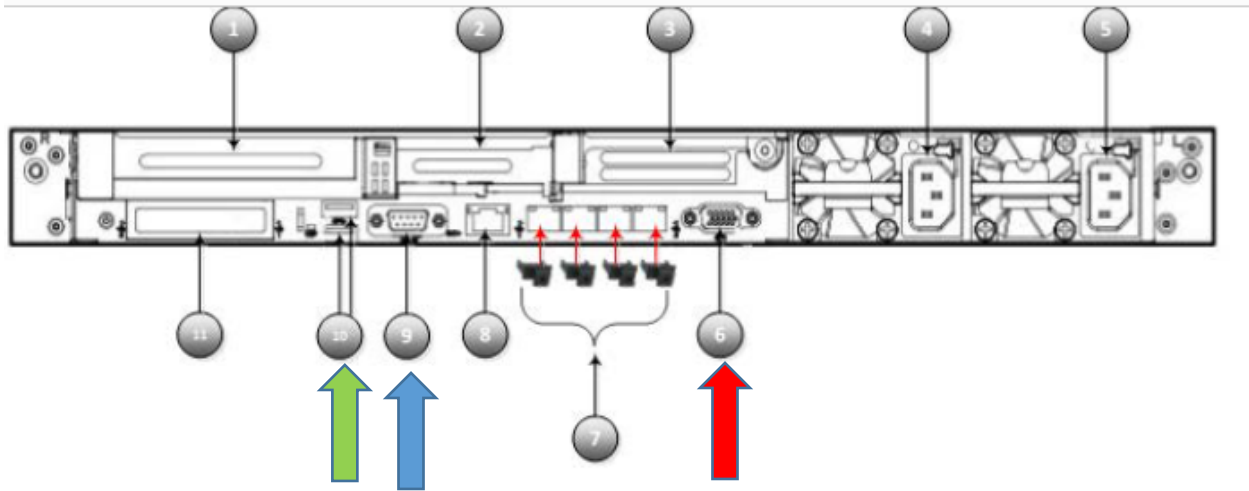

Table 3-4: Rear Panel

Item #	Description
1	Slot 1 - Quad 1-GbE copper ports
2	Slot 2 - Quad 1-GbE copper ports or Quad 10-GbE SFP+ ports
3	Slot 3 – not used
4	Power supply 2 (PS2)
5	Power supply 1 (PS1)
6	Video port
7	Unsupported NIC ports (dust covered)
8	iLO Management Port
9	Serial port
10	USB 3.0 ports
11	Quad 1-GbE copper ports

## Optional Mediant 1000B SBA interface Modules

### OSN3

CABLE ASSY OSN3 SERIAL CABLE RJ-45 TO DB-9F 1.5M RCABY0042

OSN3

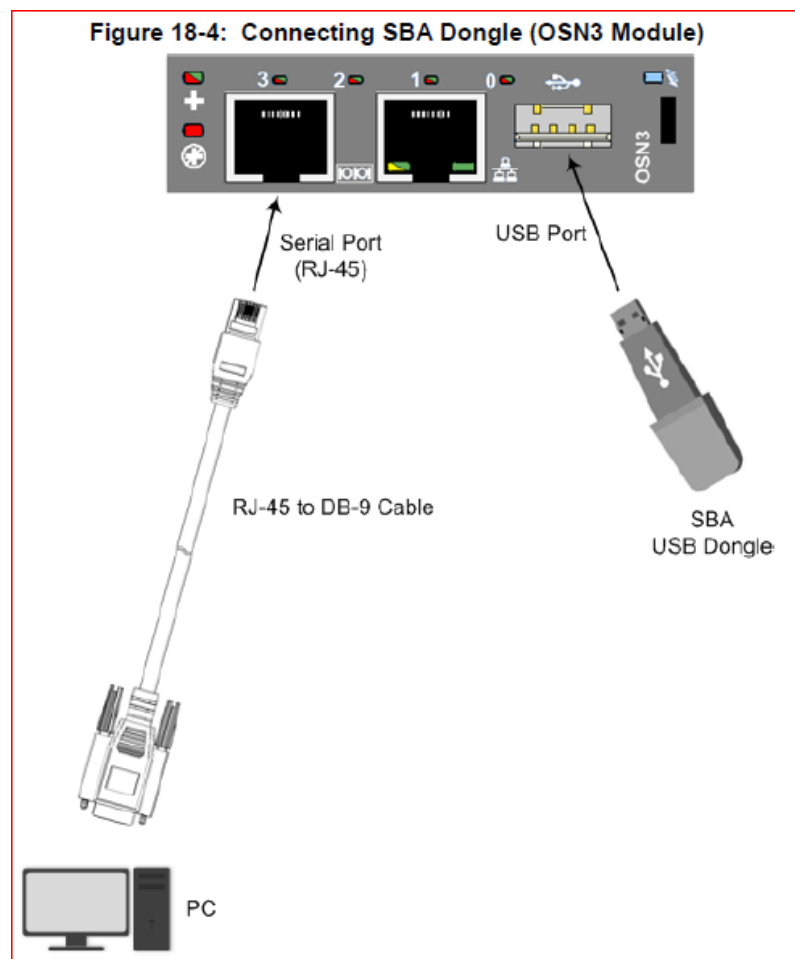

## OSN 3B and OSN 4 for the Mediant 1000B Preferred option

### Connecting SBA Dongle for HDMI Connectivity (OSN3B and OSN4 Modules)

#### Mediant 1000B-minHDMI-OSN3B/4

The commercially available Mini HDMI to HDMI cable, A to C type can be used

**USB to USB cable. Cable length 1.5 meter. Applicable for OSN3B/C and OSN4/OSN4B.** A commercially available USB hub can be used

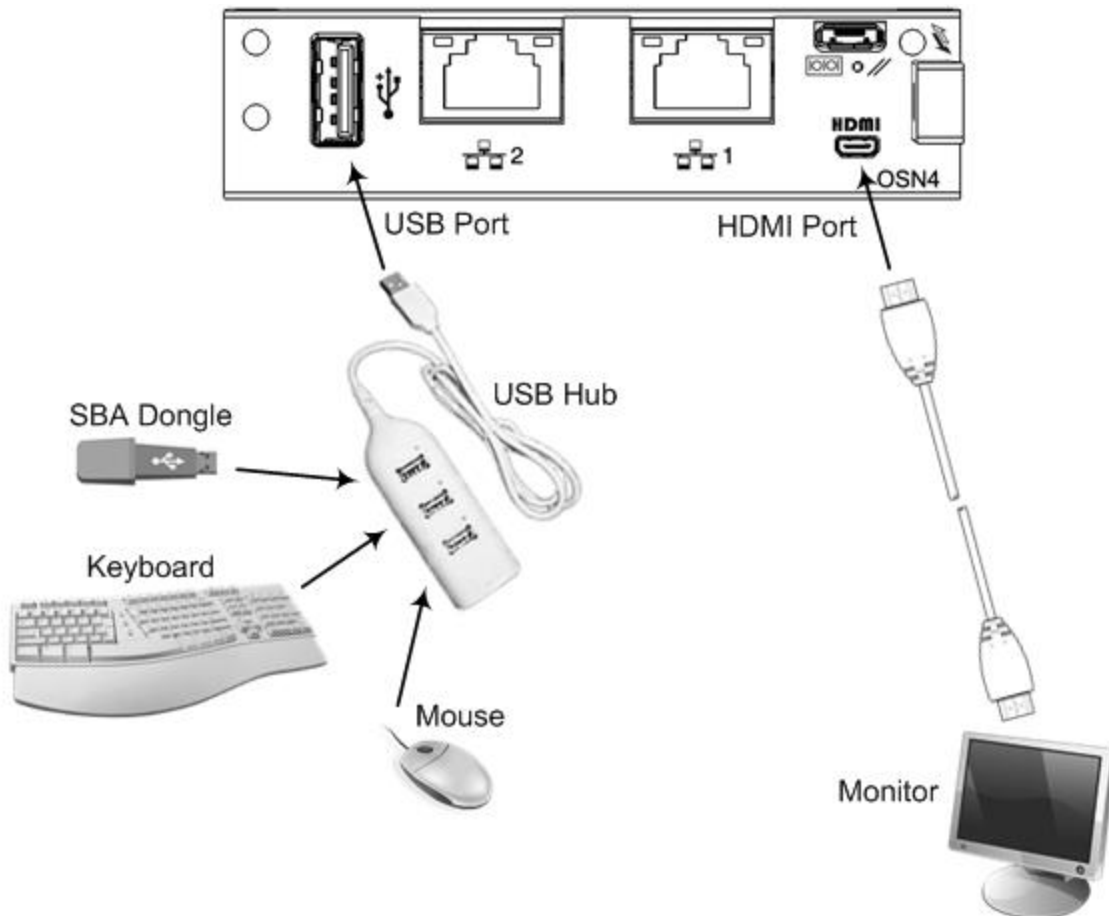

## Alternative for the Mediant 1000 SBA

### Mediant 1000B-RS232-OSN3B/4

micro USB to USB cable. Cable length 1.5 meter. Applicable for OSN3B/C and OSN4/OSN4B

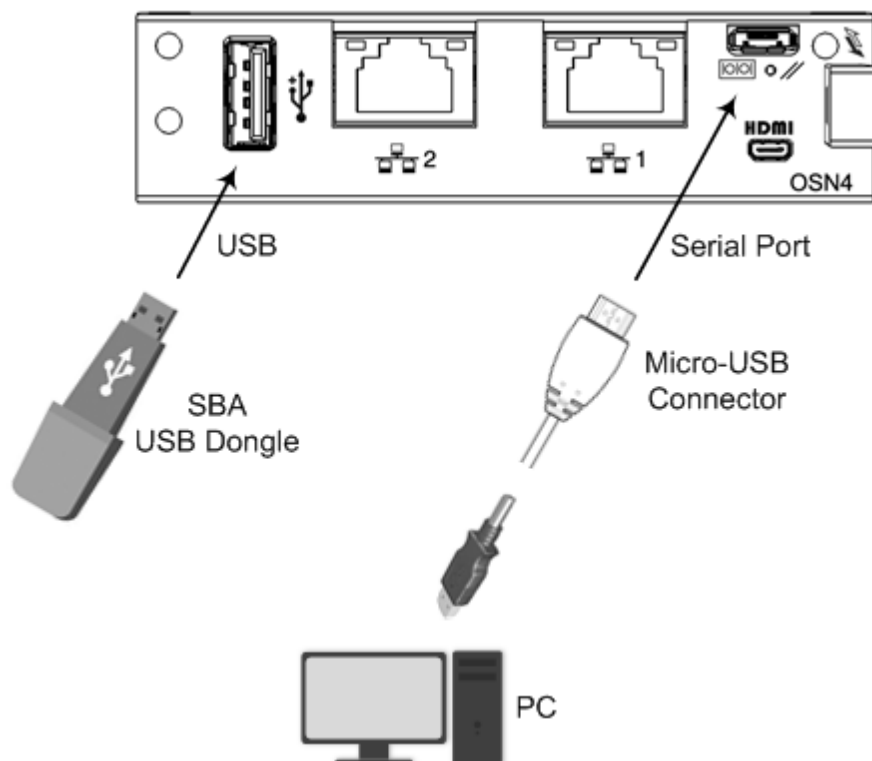

### For any further questions regarding this topic or other technical topics:

- Contact your AudioCodes Sales Engineer
- Visit our AudioCodes Services and support page at <https://www.audiocodes.com/services-support>
- Access our technical documentation library at <https://www.audiocodes.com/library/technical-documents>
- Access to AudioCodes Management Utilities is available at [https://services.audiocodes.com/app/answers/detail/a\\_id/20](https://services.audiocodes.com/app/answers/detail/a_id/20)
- Contact Technical Support to submit a support ticket at <https://services.audiocodes.com>